

Cub Cadet[®]



CATALOGUE 2018

POWER FOR YOU.

OUR HISTORY KEEPS US GOING

1961
1st Cub Cadet
hits the Market



1963
1st Shaft
Drive Model



1980
1st Super
Garden Tractor



1st Twin Cylinder
Engine



1993
1st Steerable
track Drive Snow
Thrower



1994
1st Lawn Tractor
with Shaft Drive



1966
World's 1st
Hydrostatic-Drive
Garden Tractor



1972
"Cadet" Lawn
Tractor Debuts



1985
The New Standard
in Quality of Cut



1990
Most Advanced
Garden Tractor in
Industry



2005
500 Series Lawn
Tractors – Made
in Germany

We know what our customers expect from their gardening equipment: Power, performance, endurance and durability. That's why we strive for every Cub Cadet product to be the best in class.

We continuously endeavour to further improve our product ranges, by incorporating new and proven technologies, implementing innovative engineering solutions and offering service solutions and accessory ranges that deliver true advantages.

With constantly higher quality standards and power, we ensure you get the ultimate user experience. Power you can rely on again and again.

Cub Cadet. Pure Power.

2006
Utility Vehicles
Debut

2009
Industry's Tightest
Turning Radius

2011
Celebrating
with Innovation

2013
Introduction
of Robotic
Mower

2015
MySPEED –
The innovative
VARIABLE
SPEED System

2017
Introduction of
the **PRO SERIES**
– Zero-Turns

2018
Introduction of
the 80V LI-ION
Battery DURA
SYSTEM



2007
Synchro Steer Technology
debuts, an Industry First

2010
Most Advanced
Residential
Zero-Turn with
LP Technology

2012
Introduction of
the TRILOY Series
Lawnmowers

2014
Introduction of the
innovative BOOSTED
AIRFLOW TECHNOLOGY

2017
Introduction of the
ENDURO SERIES –
XT Lawn Tractors

2018
Introduction of
the XM Series
of lawnmowers

The Cub Cadet product highlights for 2018

A NEW PROGRAMME

In POWER and PERFORMANCE.

In 2018 Cub Cadet is showcasing a range of new products which redefine the power and performance of lawn and garden machinery, including:

The complete new range of powerful, 80v lithium-ion, interchangeable battery garden tools providing a lightweight, emission-free system

Additional new petrol powered products including a new XM line up of lawnmowers, with extensive features including alloy decks, high-performance engines and modern designs

And for the professionals, there is a brand new PRO Z7 with a massive 72" fabricated cutting deck capable of running at 12mph.

Plus a whole host of improvements to our existing products...

PRO SERIES

NEW PRO SERIES MODELS

With the addition of a new top end PRO Z7 Zero-Turn to the Pro Z5 and PRO Z1, professionals are covered at all ends of the product range. The PRO Z7 has an impressive 72" (183cm) fabricated cutting deck, a 999cc commercial-grade high-performance Kawasaki engine combining economy with performance. With unrivalled comfort and manoeuvrability, the PRO series is the perfect solution for professionals.

Find out more from page 101.



XM ENDURO SERIES

A top of the line class of petrol powered self-propelled lawnmowers with variespeed and alloy decks. All models come with high-performance engines, modern design and extensive innovative features including the all new 3T technology for perfect mowing results.

Find out more from page 27.



80V 
LI-ION DURA SYSTEM

80V LITHIUM-ION BATTERY GARDEN TOOLS

Cub Cadet now offers a full line up of interchangeable lithium-ion battery powered garden tools. Developed around the impressive performance of the 80V battery power pack, each tool offers excellent run time, extensive product features and no emissions.

Find out more on page 73.



THE CUB CADET PRODUCT SERIES

EXCEED YOUR EXPECTATIONS.

Cub Cadet is constantly improving its products and customer engagement. We strive to develop strong, outstanding product classes and through the Force Series, Enduro Series™ and Pro Series, it is easy to distinguish between our product ranges. All three series are designed to meet the expectations and user requirements, so it is simple to find the right model to meet your needs.



CONTENTS

1	INTRODUCTION	01-02	New Product Highlights
		03	The Cub Cadet Product Series
		05-08	Find your Cub Cadet



2	LAWNMOWERS	11-17	LM Lawnmowers
		21-24	LM Specifications
		25-34	XM Lawnmowers
		35-36	XM Specifications



3	MINI-RIDERS	39-42	LR Mini-Riders
		43-44	LR Specifications



4	LAWN TRACTORS	47-52	LT Lawn Tractors
		53-54	LT Specifications
		57-66	XT Lawn Tractors
		67-70	XT Specifications



5	80V BATTERY GARDEN TOOLS	73-74	LI-ION DURA SYSTEM
		75	LH3 Hedge Trimmer
		76	LH3 Line Trimmer
		77	LH3 Leaf Blower
		78	LM3 Lawn Mowers
		79-80	LI-ION DURA SYSTEM Specifications



6	CHORE PERFORMERS	83	LC3 Lawn Trimmer
		84	XC3 Garden Tiller
		85	XC1 Scarifier
		86	Chore Performer Specifications



7	ZERO-TURN TRACTORS	89-90	XZ1 Lap Bar
		91-92	XZ2 Steering Wheel
		93-94	XZ3 Steering Wheel
		95-98	Zero-Turn Specifications



8	PROFESSIONAL ZERO-TURN TRACTORS	101-102	PRO Z Introduction
		103-104	PRO Z1
		105-106	PRO Z5
		107-108	PRO Z7
		109-110	Specifications



9	ACCESSORIES	113-116	Lawn Tractor Accessories
----------	--------------------	---------	--------------------------



FIND YOUR CUB CADET MODEL

FORCE SERIES FOR AMBITIOUS GARDENERS

These entry-level machines are the perfect solution if you have a medium to large sized garden and are looking for a lawnmower with power, performance and durability.

ENDURO SERIES™ FOR EXPERTS

Ideal for ambitious gardeners with a landscaped garden. If you are looking to “move up a level” then the added power and performance will allow you to finish your work faster and with better results. As an experienced gardener, you are looking for the perfect lawnmower to meet your high demands.

PRO SERIES FOR PROFESSIONALS

A must if you are a true professional, a landscape gardener who is required to professionally maintain large park areas and public green spaces on a daily basis. You place great value on premium performance, absolute reliability of your equipment and the ultimate efficiency in use.

THE FASTEST WAY TO YOUR IDEAL MODEL

Did you know that the cutting width of your lawnmower (the size of the cutting deck) is the key factor in determining how much time you need to mow your lawn. The larger the cutting width, the faster you're done!

Using the football field illustration as a guide, the diagrams on the next 3 pages will help illustrate the differences in the area of cutting achievable per hour for each of the Cub Cadet Series – Force, Enduro and PRO.

CUTTING AREA EXAMPLE

With a 42cm / 16" cutting width, you can mow a 650m² lawn in about an hour (in collecting mode). Choose a 53cm / 21" lawnmower and you could manage 950m² in the same time. Alternatively, with the 53cm / 21" cutting width, you can mow a 600m² lawn in just 40 minutes instead of an hour.



FORCE SERIES

LM LR LT

LM LAWNMOWERS

The LM lawnmowers in the FORCE SERIES are ideally suited for smaller and winding lawns. Cordless lithium-ion battery models offer lightweight mowing, push models with petrol engines cover more ground and self-propelled and MySPEED models drive the wheels as well making it even easier to cut the lawn.

LR MINI-RIDERS

These mini-riders are the perfect choice when you need to mow a sizeable lawn but have narrow passages. Easy to use and with the same strength, durability and have the same cutting characteristics of our larger tractors, just in a more compact design.

LT LAWN TRACTORS

The LT Lawn tractors are the most powerful models in the FORCE SERIES, with the largest cutting decks and biggest collection bags. With side discharge and rear collection models, dealing with larger lawns is made easy and enjoyable.

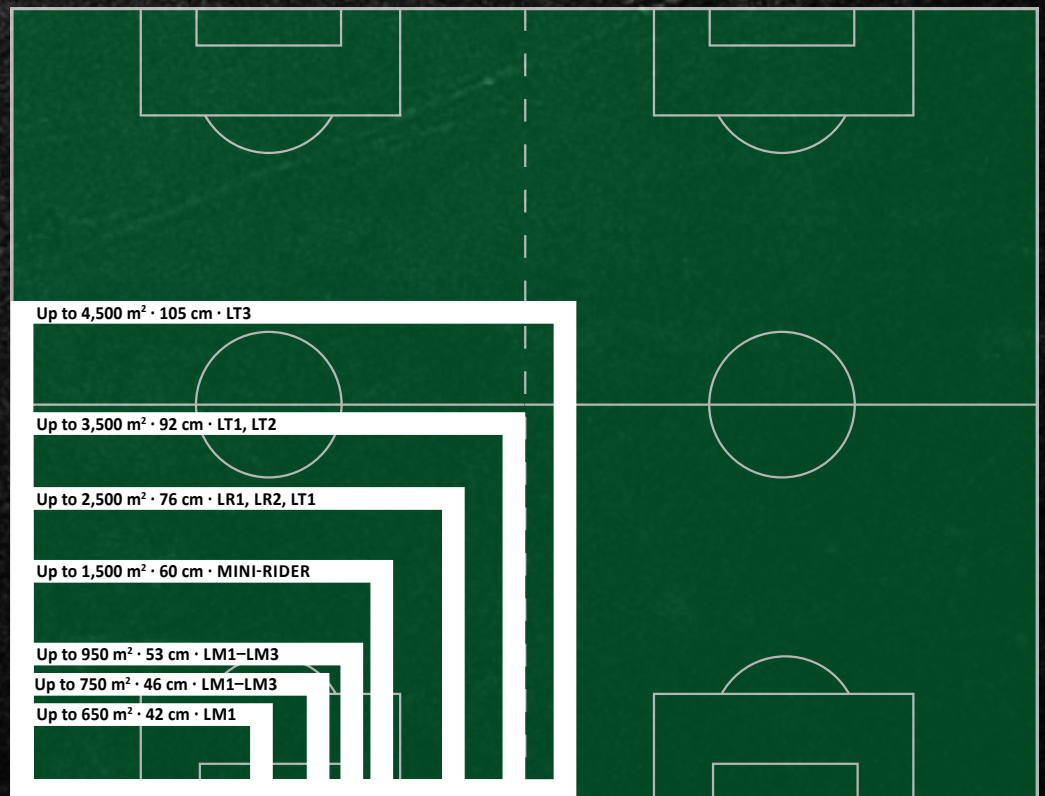
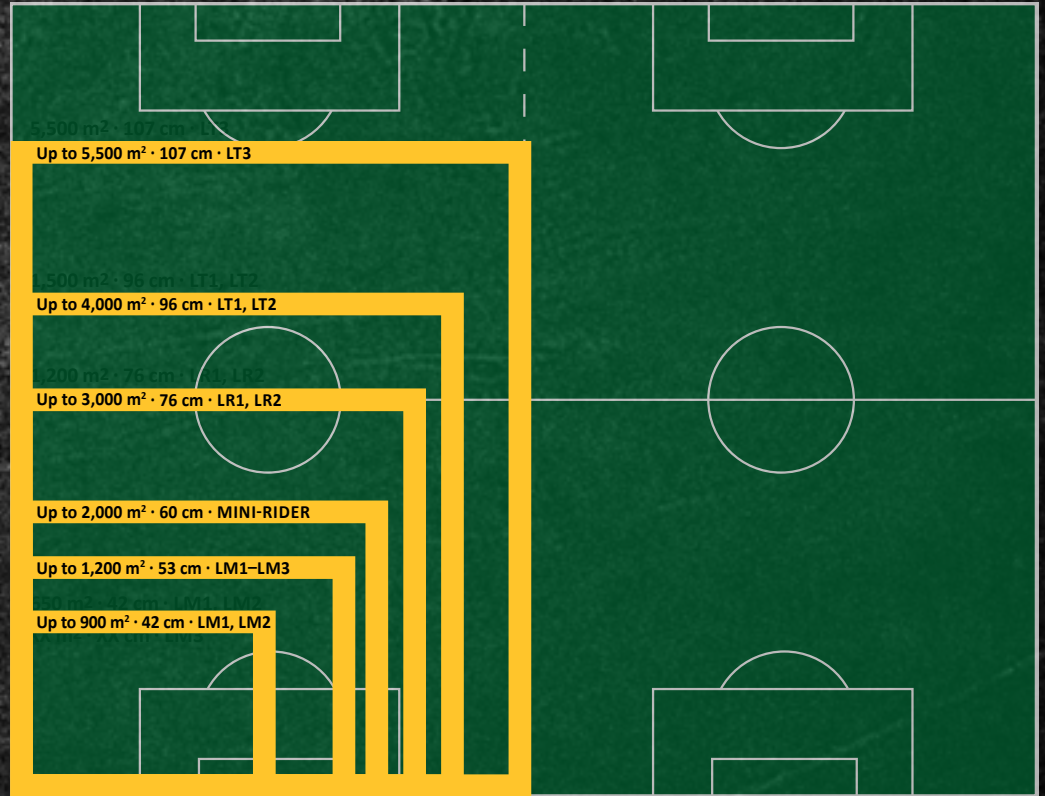

MULCHING OR DISCHARGING



COLLECTING & EMPTYING

The above illustrations are to be used as a guide only as specifications and conditions will affect performance.

ENDURO SERIES™

XM

XT

XZ

XM

LAWNMOWERS

The XM Lawnmowers in the ENDURO SERIES are a step up in performance, innovation and design and packed with extensive features including 3T technology, variable speed and high-performance engines.

XT LAWN TRACTORS

Step up to unbeatable power, performance and efficiency from a range of lawn tractors that deliver best-in-class strength, durability and quality. With market leading features including the smallest turning circle and ultra-efficient EFI engines, these are the most innovative lawn tractors we have ever built.

XZ ZERO-TURN

The XZ line up of Zero-Turns feature the innovative 360° turning technology, providing the ultimate manoeuvrability. XZ Zero-Turns with SyncroSteer benefit from full steering wheel control over all four wheels, perfect for hills and undulating terrain.

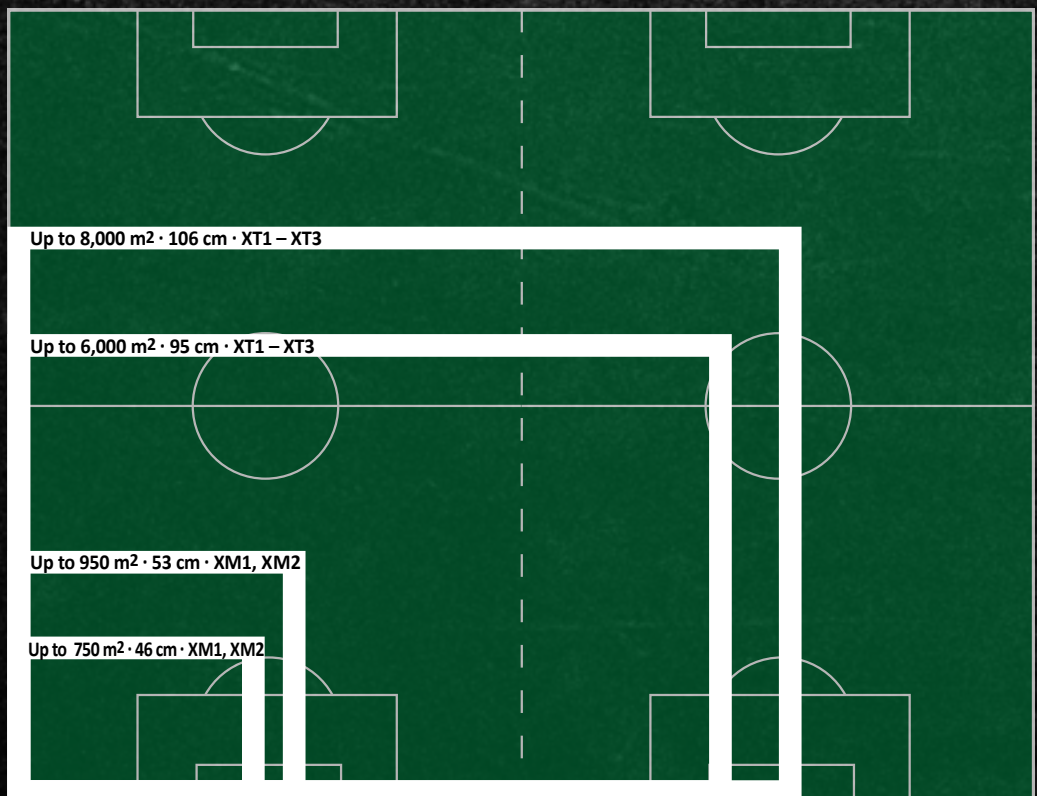
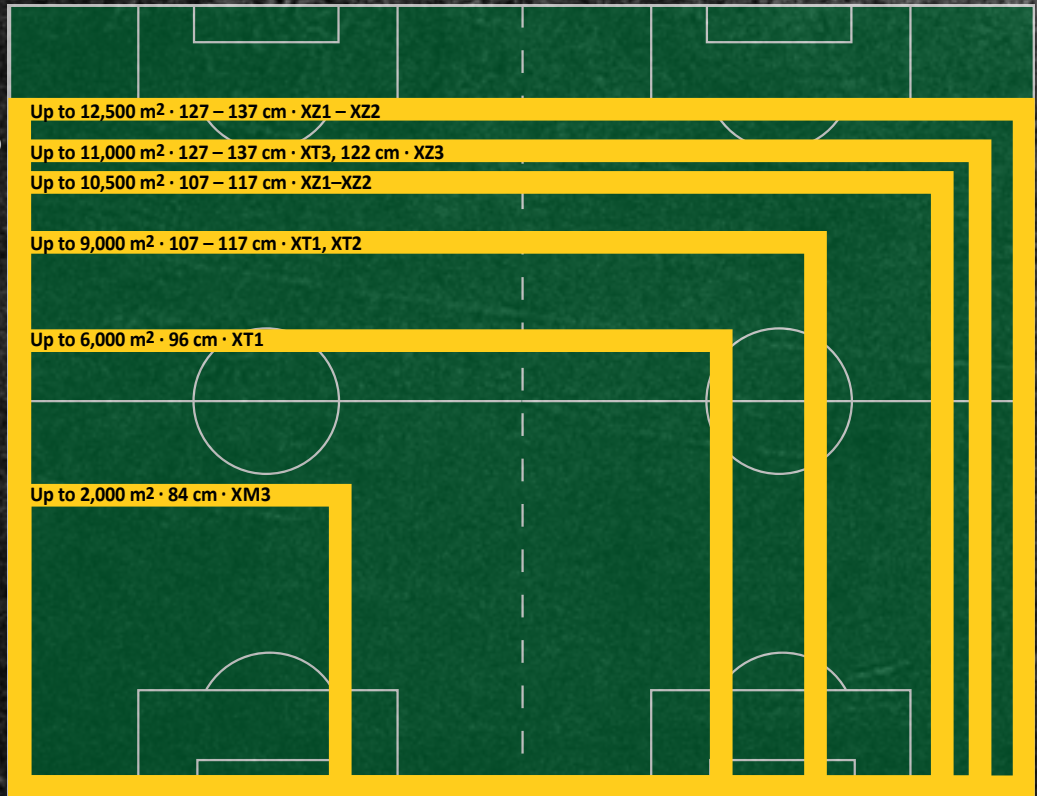

The above illustrations are to be used as a guide only as specifications and conditions will affect performance.

PRO SERIES

Z1 Z5 Z7

PRO Z ZERO-TURN

The models in the PRO SERIES are the ultimate in performance and designed to handle the serious rigors of professional users. With outstanding speed, efficiency and comfort, these machines impress users on a daily basis.



MULCHING OR
DISCHARGING



COLLECTING &
EMPTYING

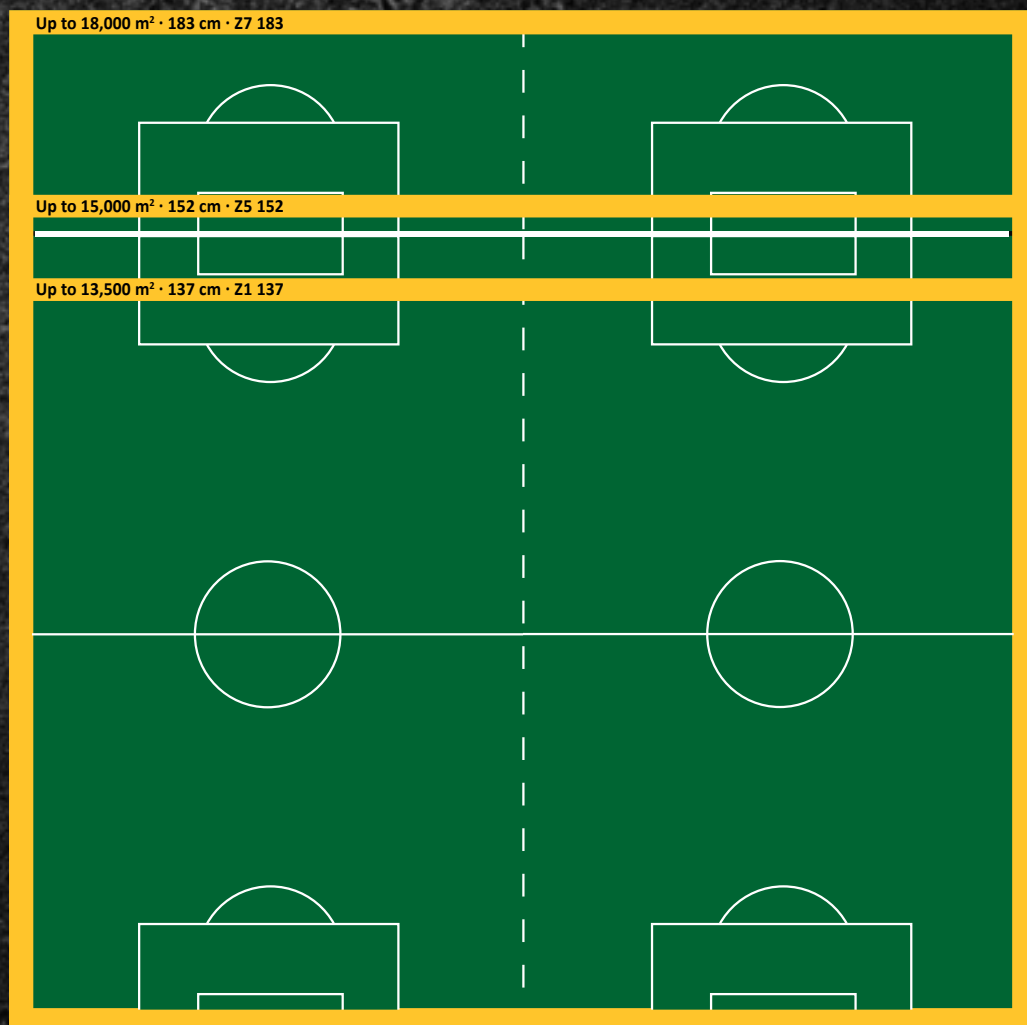

The above illustrations are to be used as a guide only as specifications and conditions will affect performance.

PROFESSIONAL ZERO-TURNS

Great Power, Zero Turning Circle



The surface area illustrations are to show what could be achieved in 1 hour with optimal mowing conditions. There are several factors which can influence performance: the texture of the lawn, (height, density, humidity), the lawn area (hills, gradients, shapes and obstacles such as trees, ponds etc) and working temperature. For hills requiring ascending and descending, we recommend a more powerful model.





**HARD WORKING.
EASY TO USE.**

LAWNMOWERS

A lawnmower should be easy to use, hard-working and deliver flawless performance with features that boast incredible control, unmatched efficiency and user comfort. If you are looking to maintain a small, irregular shaped lawn, or even larger undulating grounds, there is a size and model to meet your needs. From lithium-ion battery lawnmowers to wide cut large area mowers, all Cub Cadet lawnmowers are guaranteed to deliver the pristine Cub Cadet cut, mow after mow, season after season.



STRONG AS STEEL. EXPERTLY ENGINEERED. FLAWLESS PERFORMANCE.

Regular mowing can be beneficial for your lawn. Not only does it keep it looking good, but it also means your lawn can benefit from equal exposure to sun rays and water and is therefore healthier. Pests and weeds are also discouraged by a shorter, more maintained lawn.

Cub Cadet is pushing the boundaries of what lawnmowers can do. Our self-propelled lawnmowers are unrivaled in their strength, power and exceptional manoeuvrability and smooth operation. You're guaranteed to find a lawnmower to suit your needs and exceed your expectations.

Powered by Cub Cadet engines, these lawnmowers are easy to start, smooth running and with low noise and vibrations, they are the perfect choice for a pleasurable mowing experience. The double ball bearings on the wheels mean less friction, making it easier to glide around the garden and the ergonomic handle makes handling a breeze.

The FORCE series lawnmowers offer a range of options to suit your needs. These include: a variety of cutting decks, collection, side or rear discharge and mulching kit (which is optional on some machines). Mulching allows you to recycle the grass as you mow, putting the nutrients back into the ground, for a healthier and more vibrant lawn.

LM LAWNMOWERS. PERFECT CUT AND PERFECT COLLECTION.

Their tough construction ensures a long life cycle and the Cub Cadet OHV engine delivers power and performance to meet and exceed your demands.

With the Cub Cadet LM Range, you have the choice between collecting and discharging the clippings and lots of other useful features including easy-to-empty grass bag, ergonomically formed handle, convenient central height adjustment and ball bearing wheels. Mowing the lawn with a LM lawnmower is more pleasure, than chore.

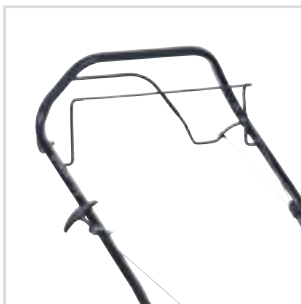

ERGONOMIC HANDLE

Ergonomic handle gives you full control of the lawnmower with the most comfortable hand position. The handle is fully foldable for space-saving storage and easy transport.



CENTRAL CUTTING HEIGHT ADJUSTMENT

It has never been easier to adjust the cutting height. Comfortably change the cutting height centrally with one lever, providing the choice of six different positions.



LARGE GRASS BAG

A large grass bag reduces the amount of time emptying it, enabling quicker mowing and reducing the number of trips to the compost heap.

The cloth bag fits through the mowers handle to secure in place and can easily be removed. A quick, simple and efficient system.



LM1 AP42

Cutting width:	42 cm / 16 "
Engine:	Cub Cadet 35 OHV, 99 cm ³ Pull start
Rated power:	1.6 kW / 2,800 min ⁻¹
Drive:	Push

Model no.: 11A-LQSJ603



LM1 AR42

Cutting width:	42 cm / 16 "
Engine:	Cub Cadet 35 OHV, 99 cm ³ , Pull start
Rated power:	1.6 kW / 2,800 min ⁻¹
Drive:	Self-Propelled

Model no.: 12A-LQSJ603

2

LAWNMOWERS

1

3

4

5

6

7

8

9

3-in-1 OPTION

COLLECT, DISCHARGE & OPTIONAL MULCHING.

3-in-1 option means that you have the choice between collecting the clippings, or discharging them out the back. You also have the option to buy an additional mulch kit as an accessory.



LM1 AP46

Cutting width:	46 cm / 18 "
Engine:	Cub Cadet 35 OHV, 99 cm ³ , Pull start
Rated power:	1.6 kW / 2,800 min ⁻¹
Drive:	Push

Model no.: 11A-TQSJ603



LM1 AR46

Cutting width:	46 cm / 18 "
Engine:	Cub Cadet 35 OHV, 99 cm ³ , Pull start
Rated power:	1.6 kW / 2,800 min ⁻¹
Drive:	Self-Propelled

Model no.: 12A-TQSJ603



LM1 CR53

Cutting width:	53 cm / 21 "
Engine:	Cub Cadet 45 OHV, 140 cm ³ , Pull start
Rated power:	2.1 kW / 2,800 min ⁻¹
Drive:	Self-Propelled

Model no.: 12A-PQSC603



Cub Cadet engines with auto choke are easy to start, smooth running and with low noise and vibration, are the perfect choice for a pleasurable mowing experience.



MULCHING LAWNMOWERS. CLEVER AND ENVIRONMENTALLY CONSCIOUS.

Everyone who likes beautifully groomed lawns should have a mulching lawnmower to optimise the nutrient cycle of the lawn. Our mulching mowers are perfect for this type of lawn care with the grass being cut several times and then equally distributed onto the ground where it can be used as a natural green fertiliser. This saves on fertilisers, which is not only good for the environment but good for your wallet as well. Another benefit of a mulching mower is that there is no collecting or grass disposal, meaning you do not have to stop to empty the grass bag which is a great time saver.



- 1
- 2
- LAWN MOWERS
- 3
- 4
- 5
- 6
- 7
- 8
- 9



LM1 DP53	
Cutting width:	53 cm / 21 "
Engine:	Cub Cadet 55 OHV, 159 cm ³ , Pull start
Rated power:	2.5 kW / 2,850 min ⁻¹
Drive:	Push

Model no.: 11A-A02P603 **SPECIAL ORDER**



LM1 DF53	
Cutting width:	53 cm / 21 "
Engine:	Cub Cadet 55 OHV, 159 cm ³ , Pull start
Rated power:	2.5 kW / 2,900 min ⁻¹
Drive:	Front wheel

Model no.: 12A-A02P603 **SPECIAL ORDER**



EFFORTLESS
DRIVE CONTROL
MySPEED™

THE STRONGEST WAY TO POWER WALK.

The intuitive, state-of-the-art MySPEED™ handle on our LM2 and LM3 Lawnmowers means that the lawnmower drives at your walking speed. Simply grab the handle, start to walk and see how easy and relaxing mowing can be.

The MySPEED™ system delivers high-performance and industry-leading control with ultra-soft rubber grips to reduce vibrations and operator fatigue. With a MySPEED™ equipped lawnmower, you will experience smoother engagement, superior speed variability and enhanced traction – all with no effort and whilst simply walking at your natural pace.

MySPEED

THE MySPEED™ DRIVE SYSTEM.

The intuitive MySPEED™ drive system engages once the handle is pushed forward. If you walk faster, the handle is naturally pushed further forward and the lawnmower speed increases effortlessly.

If you walk slower, the handle automatically pivots back and the lawnmower slows down. If you stop walking, the handle moves to neutral and the lawnmower stands still, ready to move when you do.

When in motion, the lawnmower speed reacts to your desired walking speed, meaning a relaxed and natural mowing experience.

TIP: Do not pivot the handle forward to engage the MySPEED™ drive system. Simply grab the handle and start to walk normally. The handle will gradually pivot forward and the lawnmower will start to move forward with you.



ELECTRIC START
Get your lawnmower started with the turn of a key.



LARGE GRASS BAG
A large grass bag reduces the amount of time spent emptying it, enabling quicker mowing and reducing the number of trips to the compost heap.



HEIGHT ADJUSTABLE HANDLE
The handle can be matched to your preferred height, providing a stress and fatigue free mowing experience.



MySPEED™ VARIABLE SPEED CONTROL
With a variable drive speed system you will set your mowing pace, not the lawnmower.



CENTRAL CUTTING HEIGHT ADJUSTMENT
One lever adjusts all four wheels simultaneously. The conveniently placed central lever enables six different cutting heights from 28 – 92mm.



POWERED BY CUB CADET
Cub Cadet engines with auto choke are easy to start, smooth running and with low noise and vibration, are the perfect choice for a pleasurable mowing experience.



SELF-PROPELLED LAWNMOWERS

3-in-1

COLLECT, DISCHARGE & MULCHING.

3-in-1 means that you have the choice between collecting the clippings, discharging them out the back, or mulching.



LM2 DR46s

Cutting width:	46 cm / 18 "
Engine:	Cub Cadet 55 OHV, 159 cm ³ , Pull start
Rated power:	2.5 kW / 2,800 min ⁻¹
Drive:	MySPEED

Model no.: 12BBTQKC603



LM2 DR46es

Cutting width:	46 cm / 18 "
Engine:	Cub Cadet 55 OHV ES, 159 cm ³ , Electric start
Rated power:	2.5 kW / 2,800 min ⁻¹
Drive:	MySPEED

Model no.: 12BCTQS7603



LM2 DR53s

Cutting width:	53 cm / 21 "
Engine:	Cub Cadet 55 OHV, 159 cm ³ , Pull start
Rated power:	2.5 kW / 2,800 min ⁻¹
Drive:	MySPEED

Model no.: 12BBPQKC603

4-in-1

COLLECTION, REAR DISCHARGE, SIDE DISCHARGE & MULCHING.

4-in-1 means you have the choice of four different options for disposing of the grass clippings, giving you the flexibility to mow your way. A 4-in-1 lawnmower offers the freedom to select the ideal discharge solution for all conditions.



MySPEED™ VARIABLE SPEED CONTROL

With a variable drive speed system you will set your mowing pace, not the lawnmower.



EASY STARTING B&S ENGINE

The Briggs & Stratton engines with ReadyStart® technology and starting guarantee lets you start the mower with confidence and ease. The engine will start after two pulls.



HIGH WHEELS

Excellent manoeuvrability is a key factor on a good lawnmower. High rear wheels let the lawnmower drive over lush grass and uneven terrain with less effort and ensures a much smoother ride.



HARD TOP BAG WITH FILL INDICATOR

The dust proof hard top keeps dust down during dry periods and the fill indicator flap signals when the grass bag is ready to be emptied.



LM3 CR46s

Cutting width:	46 cm / 18 "
Engine:	B&S 575 EX-Series, 140 cm ³ , Pull start
Rated power:	2.1 kW / 2,800 min ⁻¹
Drive:	MySPEED, High wheel

Model no.: 12BBTV5E603



LM3 CR53s

Cutting width:	53 cm / 21 "
Engine:	B&S 625 E-Series, 150 cm ³ , Pull start
Rated power:	2.2 kW / 2,800 min ⁻¹
Drive:	MySPEED, High wheel

Model no.: 12BBPV5L603

2

SELF-PROPELLED LAWNMOWERS

1

3

4

5

6

7

8

9

POWERED BY
Cub Cadet

4-in-1
MYSPEED



LM3 DR53es

Cutting width:	53 cm / 21 "
Engine:	Cub Cadet 55 OHV ES, 159 cm ³ , Electric start
Rated power:	2.5 kW / 2,800 min ⁻¹
Drive:	MySPEED, High wheel

Model no.: 12BCPVS7603



FEATURES OF THE CASTER WHEEL LM3 ER53.

Exceptional handling, zero-turn capability and two front caster wheels which can be locked into place for straight line mowing, the LM3 ER53 is the ultimate handling walk behind lawnmower.



VARIABLE DRIVE SPEED

With six variable drive speeds from 2.8 - 4.5km/h, you can select the right speed to meet your specific needs across the entire garden.



LARGE GRASS BAG

A large grass bag reduces the amount of time emptying it, enabling quicker mowing and reducing the number of trips to the compost heap.



FRONT CASTER WHEELS

With the caster wheels this lawnmower gives you the ultimate manoeuvrability and is perfect when there are many obstacles on the lawn, such as bushes and trees.



ERGONOMIC HANDLE

Ergonomic handle gives you full control of the lawnmower with the most comfortable hand position. The handle is fully foldable for space-saving storage and easy transport.



POWERED BY
Cub Cadet

3-in-1

LM3 ER53	
Cutting width:	53 cm / 21 "
Engine:	Cub Cadet 60 OHV, 195 cm ³ , Pull start
Rated power:	3.3 kW / 2,750 min ⁻¹
Drive:	Self-Propelled



Model no.: 12AQC6J4603





- 1
- 2
- 3
- 4
- 5
- 6
- 7
- 8
- 9

SELF-PROPELLED LAWNMOWERS

	LM1 AP42	LM1 AR42	LM1 AP46	
ENGINE	Engine type	Cub Cadet 35 OHV	Cub Cadet 35 OHV	Cub Cadet 35 OHV
	Engine displacement	99 cm ³	99 cm ³	99 cm ³
	Rated power	1.6 kW / 2,800 min ⁻¹	1.6 kW / 2,800 min ⁻¹	1.6 kW / 2,800 min ⁻¹
	Engine start	Pull	Pull	Pull
	Tank volume (capacity)	0.75 l	0.75 l	0.75 l
DRIVE SYSTEM	Drive	Push	Rear-wheel-drive	Push
	Number of speeds	-	Single	-
	Speed (max)	-	3.6 km/h	-
CUTTING SYSTEM	Mowing area in m ² /h	650	650	700
	Cutting deck (material)	Steel	Steel	Steel
	Cutting width	42 cm / 16 "	42 cm / 16 "	46 cm / 18 "
	Cutting options	3-in-1 Option	3-in-1 Option	3-in-1 Option
	Cutting height adjustment	6 Positions / central	6 Positions / central	6 Positions / central
	Cutting height (min-max)	28-92 mm	28-92 mm	28-92 mm
	Grass catcher	Standard	Standard	Standard
	Mulching plug (product code)	available as an accessory (196-587-678)	available as an accessory (196-587-678)	available as an accessory (196-588-678)
	Side discharge	-	-	-
	Rear discharge without collector	Standard	Standard	Standard
BAGGING	Grass catcher type	Soft bag	Soft bag	Soft bag
	Grass catcher capacity	60 l	60 l	60 l
	Bag full indicator	-	-	-
WHEELS	Wheels (F/R)	180 mm / 200 mm (7 " / 8 ")	180 mm / 200 mm (7 " / 8 ")	180 mm / 200 mm (7 " / 8 ")
	Double ball bearings	Standard	Standard	Standard
COMFORT	Washing nozzle	Standard	Standard	Standard
	Handle type	Ergonomic	Ergonomic	Ergonomic
	Foldable handle	Standard	Standard	Standard
	Height adjustable handle	Standard	Standard	Standard
DIMENSIONS	LpA / LwA / LwAg (dB)	84 / 94 / 96	84 / 94 / 96	84 / 94 / 96
	Dimensions (L/W/H)	150 cm / 46 cm / 114 cm	155 cm / 46 cm / 99 cm	155 cm / 49 cm / 114 cm
	Weight net	28 kg	31 kg	28 kg
Model number	11A-LQ SJ603	12A-LQ SJ603	11A-TQ SJ603	
EAN	 4 008423 872613	 4 008423 872781	 4 008423 872798	

LM1 AR46	LM1 CR53	LM1 DP53	LM1 DF53
Cub Cadet 35 OHV	Cub Cadet 45 OHV	Cub Cadet 55 OHV	Cub Cadet 55 OHV
99 cm ³	140 cm ³	159 cm ³	159 cm ³
1.6 kW / 2,800 min ⁻¹	2.1 kW / 2,800 min ⁻¹	2.5 kW / 2,900 min ⁻¹	2.5 kW / 2,900 min ⁻¹
Pull	Pull	Pull / Auto Choke	Pull / Auto Choke
0.75 l	1.0 l	1.0 l	1.0 l
Rear-wheel-drive	Rear-wheel-drive	Push	Front-wheel-drive
Single	Single	-	Single
3.6 km/h	3.6 km/h	-	3.6 km/h
700	950	1200	1200
Steel	Steel	Steel	Steel
46 cm / 18 "	53 cm / 21 "	53 cm / 21 "	53 cm / 21 "
3-in-1 Option	3-in-1 Option	2-in-1	2-in-1
6 Positions / central	6 Positions / central	9 Individual	9 Individual
28–92 mm	28–92 mm	35–100 mm	35–100 mm
Standard	Standard	-	-
available as an accessory (196-588-678)	available as an accessory (196-589-678)	Standard	Standard
-	-	Standard	Standard
Standard	Standard	-	-
Soft bag	Soft bag	-	-
60 l	70 l	-	-
-	-	-	-
180 mm / 200 mm (7 " / 8 ")	200 mm / 200 mm (8 " / 8 ")	180 mm / 200 mm (7 " / 8 ")	200 mm / 200 mm (8 " / 8 ")
Standard	Standard	Standard	Standard
Standard	Standard	-	-
Ergonomic	Ergonomic	Ergonomic	Ergonomic
Standard	Standard	Standard	Standard
Standard	Standard	Standard	Standard
84 / 94 / 96	86 / 96 / 98	86 / 96 / 98	86 / 96 / 98
155 cm / 49 cm / 114 cm	162 cm / 58 cm / 114 cm	154 cm / 57 cm / 104 cm	160 cm / 57 cm / 105 cm
31 kg	34 kg	26 kg	26 kg
12A-TQSJ603	12A-PQSC603	11A-A02P603	12A-A02P603
 4 008423 872620	 4 008423 872637	 4 008423 859331	 4 008423 859348

	LM2 DR46s	LM2 DR46es	LM2 DR53s	
ENGINE	Engine type	Cub Cadet 55 OHV	Cub Cadet 55 OHV ES	Cub Cadet 55 OHV
	Engine displacement	159 cm ³	159 cm ³	159 cm ³
	Rated power	2.5 kW / 2,800 min ⁻¹	2.5 kW / 2,800 min ⁻¹	2.5 kW / 2,800 min ⁻¹
	Engine start	Pull / Auto Choke	Electric Start	Pull / Auto Choke
	Tank volume (capacity)	1.0 l	1.0 l	1.0 l
DRIVE SYSTEM	Drive	Rear-wheel-drive	Rear-wheel-drive	Rear-wheel-drive
	Number of speeds	Variable	Variable	Variable
	Speed (max)	0–3.6 km/h	0–3.6 km/h	0–3.6 km/h
CUTTING SYSTEM	Mowing area in m ² /h	750	750	950
	Cutting deck (material)	Steel	Steel	Steel
	Cutting width	46 cm / 18 "	46 cm / 18 "	53 cm / 21 "
	Cutting options	3-in-1	3-in-1	3-in-1
	Cutting height adjustment	6 Positions / central	6 Positions / central	6 Positions / central
	Cutting height (min–max)	28–92 mm	28–92 mm	28–92 mm
	Grass catcher	Standard	Standard	Standard
	Mulching plug	Standard	Standard	Standard
	Side discharge	-	-	-
	Rear discharge without collector	Standard	Standard	Standard
BAGGING	Grass catcher type	Soft bag	Soft bag	Soft bag
	Grass catcher capacity	60 l	60 l	70 l
	Bag full indicator	-	-	-
WHEELS	Wheels (F/R)	180 mm / 200 mm (7 " / 8 ")	180 mm / 200 mm (7 " / 8 ")	200 mm / 200 mm (8 " / 8 ")
	Double ball bearings	Standard	Standard	Standard
COMFORT	Washing nozzle	Standard	Standard	Standard
	Handle type	MySPEED	MySPEED	MySPEED
	Foldable handle	Standard	Standard	Standard
	Height adjustable handle	Standard	Standard	Standard
DIMENSIONS	LpA / LwA / LwAg (dB)	84 / 94 / 96	84 / 94 / 96	86 / 96 / 98
	Dimensions (L/W/H)	150 cm / 49 cm / 114 cm.	150 cm / 49 cm / 114 cm	162 cm / 58 cm / 114 cm
	Weight net	31 kg	35 kg	39 kg
Model number	12BBTQKC603	12BCTQS7603	12BBPQKC603	
EAN	 4 008423 866148	 4 008423 866247	 4 008423 866131	

LM3 CR46s	LM3 CR53s	LM3 DR53es	LM3 ER53
B&S 575 EX Series, Ready Start	B&S 625 E Series, Ready Start	Cub Cadet 55 OHV ES	Cub Cadet 60 OHV
140 cm ³	150 cm ³	159 cm ³	195 cm ³
2.1 kW / 2,800 min ⁻¹	2.2 kW / 2,800 min ⁻¹	2.5 kW / 2,800 min ⁻¹	3.3 kW / 2,750 min ⁻¹
Pull	Pull	Electric Start	Pull / Auto Choke
0.8 l	1.0 l	1.0 l	1.1 l
Rear-wheel-drive	Rear-wheel-drive	Rear-wheel-drive	Rear-wheel-drive
Variable	Variable	Variable	6
0–3.6 km/h	0–3.6 km/h	0–3.6 km/h	2.8–4.5 km/h
750	950	950	950
Steel	Steel	Steel	Steel
46 cm / 18 "	53 cm / 21 "	53 cm / 21 "	53 cm / 21 "
4-in-1	4-in-1	4-in-1	3-in-1
6 Positions / central	6 Positions / central	6 Positions / central	6 Individual front / central rear
28–92 mm	28–92 mm	28–92 mm	28–92 mm
Standard	Standard	Standard	Standard
Standard	Standard	Standard	Standard
Standard	Standard	Standard	Standard
Standard	Standard	Standard	Standard
Soft bag with hard top	Soft bag with hard top	Soft bag with hard top	Soft bag
60 l	70 l	70 l	70 l
Standard	Standard	Standard	-
180 mm / 280 mm (7 " / 11 ")	200 mm / 280 mm (8 " / 11 ")	200 mm / 280 mm (8 " / 11 ")	180 mm / 200 mm (7 " / 8 ")
Standard	Standard	Standard	Standard
Standard	Standard	Standard	Standard
MySPEED	MySPEED	MySPEED	Ergonomic
Standard	Standard	Standard	Standard
Standard	Standard	Standard	Standard
84 / 94 / 96	86 / 96 / 98	86 / 96 / 98	86 / 96 / 98
155 cm / 49 cm / 114 cm	162 cm / 58 cm / 114 cm	162 cm / 58 cm / 114 cm	167 cm / 57 cm / 104 cm
39 kg	36 kg	41 kg	37 kg
12BBTV5E603	12BBPV5L603	12BCPV57603	12AQC6J4603
 4 008423 855425	 4 008423 859355	 4 008423 866155	 4 008423 858204



XM

ENDURO SERIES™



MOWING PERFECTION.

XM SERIES

The new XM lawnmowers in the ENDURO SERIES break new ground when it comes to power, performance and precision. The premium aluminium decks are durable and easy to clean with smooth, balanced engines delivering exceptional performance with minimal vibrations. The XM Lawnmowers benefit from Cub Cadet 3T Technology, ensuring perfect mowing results cut after cut, season after season.

Innovative functionality combined with modern design and exceptional performance, the XM range of lawnmowers offer mowing perfection.

THE BEST CUB CADET MOWERS ON THE MARKET



Cub Cadet 3T Technology ensures perfect mowing results, cut after cut, season after season.



ROBUST DESIGN AND HIGH-QUALITY COMPONENTS

The single die-cast aluminium housing is ultra-robust: free of any screws that can come loose. Tough front and side bumpers protect the mower against obstacles.



POWERFUL ENGINES WITH LARGE DISPLACEMENT

Cub Cadet ENGINES XM mowers except the XM2 DR46 and XM3 KR84es come complete with powerful Cub Cadet engines that extend the service life and perform outstandingly, particularly on tall grass.

HONDA ENGINE The XM2 DR46 mower features a Honda engine (160 cm³) that minimises both noise and vibration while in operation.



FAST CLEANING

An integrated mowing deck washing nozzle and a special cleaning position mean raising, rinsing and cleaning the body couldn't be easier.

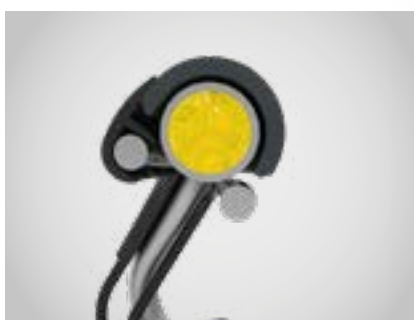

VIBEX CUSHIONING GEL VIBEX cushioning gel in the handle significantly reduces vibrations.



TOP-QUALITY WHEELS, EACH WITH DOUBLE BALL BEARINGS





- ① A CHOICE OF AVAILABLE TRANSMISSION TYPES
- ② GRASS CATCHER (65/75 LITRES) WITH LEVEL INDICATOR & DUST COVER
- ③ EASILY ADJUSTABLE BAR HEIGHT
- ④ COMFORTABLE CENTRAL 6-STEP CUTTING HEIGHT ADJUSTMENT
- ⑤ HANDLE FEATURING MARKET-LEADING ERGONOMIC DESIGN – MINIMAL EFFORT REQUIRED
- ⑥ ELECTRIC START AT THE TOUCH OF A BUTTON (XM2 ER53E)

—3T— *Cub Cadet* TECHNOLOGY

A DISCHARGE CHUTE FOR EXCELLENT GRASS COLLECTION

- Mower housing with specially designed geometry
- Cuttings are transported through the turbo tunnel directly to the grass catcher
- Improved mowing performance



AVS ANTI-VIBRATION SYSTEM
Special axle dampers above the deck absorb vibrations from the engine.



SINGLE SPEED
(XM1 DR46, XM1 ER53)



VARIOSPEED - SIX SPEEDS,
PERFECT FOR ANY SETTING
(XM2 DR46, XM2 ER53e)



ULTRA-ROBUST WHEELS
FOR OPTIMAL RUNNING
PERFORMANCE AND DURABILITY

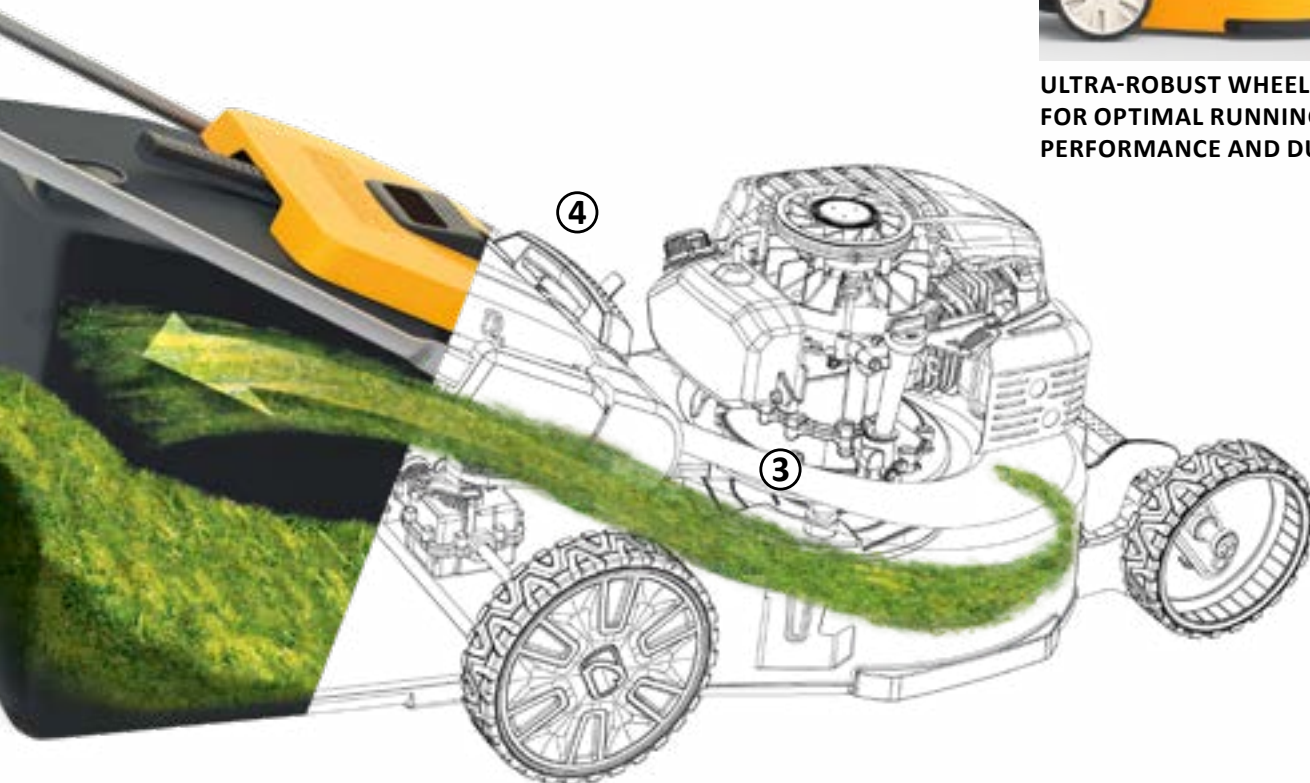

2

SELF-PROPELLED LAWNMOWERS

1

3

4

5

6

7

8

9



UNDERPINNING THE VERY BEST RESULTS

The Cub Cadet XM1 raises the bar in lawnmower performance. Packed with must-have features, this series guarantees the best in mowing results.

XM1 – SPECIAL ADVANTAGES:



FAST CLEANING

The mower stands firmly when turned over for easy access to the blades and mowing deck. The integrated mowing deck washing nozzle cleans the housing.



SINGLE SPEED



AVS ANTI-VIBRATION SYSTEM

Super-low vibration thanks to the axle with special shock absorbers and an anti-vibration ring between the mowing deck and engine as well as specially developed VIBEX cushioning gel in the handle.



VIBEX CUSHIONING GEL

VIBEX cushioning gel in the handle significantly reduces vibrations.

—3T— *Cub Cadet* TECHNOLOGY

A DISCHARGE CHUTE FOR EXCELLENT GRASS COLLECTION

- Mower housing with specially designed geometry
- Cuttings are transported through the turbo tunnel directly to the grass catcher
- Improved mowing performance



TURBO TUNNEL

A specially developed geometry inside the mower housing ensures all cuttings are transported through a **turbo tunnel** into the grass catcher. Improving mowing performance because no more cuttings get stuck or left on the lawn.



POWERFUL CUB CADET ENGINE

Delivers the power needed for easier and faster mowing. Ultra-durable engines offer unrivalled performance, especially on long grass.



ROBUST DESIGN AND HIGH-QUALITY COMPONENTS

The single die-cast aluminium housing is ultra-robust: free of any screws that can come loose. Tough front and side bumpers protect the mower against obstacles.



ULTRA-ROBUST WHEELS FOR OPTIMAL RUNNING PERFORMANCE AND DURABILITY

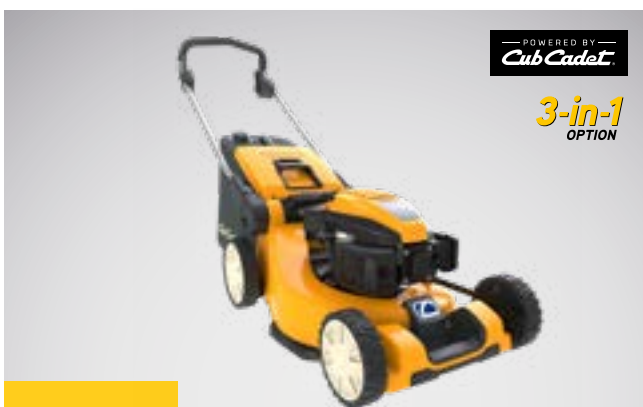

XM1 DR46

SIMILAR TO PHOTO

NEW

Cutting width:	46 cm / 18"
Recommended area capacity:	750 m ² /h
Collecting volume:	65 l
Engine:	Cub Cadet 55 OHV, recoil starter
Engine displacement:	159 cm ³
Drive:	Single speed/rear-wheel drive
Cutting height adjustment:	6 positions/central

Model no.: 12A-YAKC603

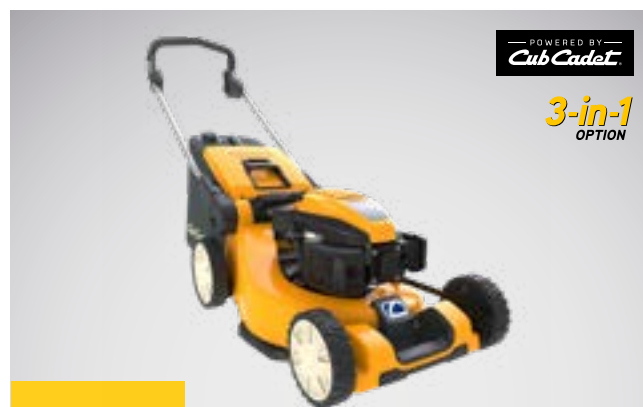

XM1 ER53

SIMILAR TO PHOTO

NEW

Cutting width:	53 cm / 21"
Recommended area capacity:	950 m ² /h
Collecting volume:	75 l
Engine:	Cub Cadet 65 OHV, recoil starter
Engine displacement:	196 cm ³
Drive:	Single speed/rear-wheel drive
Cutting height adjustment:	6 positions/central

Model no.: 12A-ZAJ4603

2

SELF-PROPELLED LAWNMOWERS

1

3

4

5

6

7

8

9



EVERYTHING A POWER MOWER NEEDS

The Cub Cadet XM2 lawnmower offers you the best of all worlds, incorporating VarioSpeed and Cub Cadet 3T Technology.

XM2 – SPECIAL ADVANTAGES:



FAST CLEANING

The mower stands firmly when turned over for easy access to the blades and mowing deck. The integrated mowing deck washing nozzle cleans the housing.



AVS ANTI-VIBRATION SYSTEM

Super-low vibration thanks to the axle with special shock absorbers and an anti-vibration ring between the mowing deck and engine as well as specially developed VIBEX cushioning gel in the handle.



VARIOSPEED - 6 SPEEDS, PERFECT FOR ANY SETTING



VIBEX CUSHIONING GEL HANDLE

VIBEX cushioning gel in the handle significantly reduces vibrations.

XM2 – STAND-OUT ADVANTAGES:



Cub Cadet
VARIOSPEED

XM ENDURO SERIES lawnmowers with VarioSpeed offer a self-propelled drive with six speed steps – comparable to car gears. Making the speed adjustable to suit your requirements.



–3T– *Cub Cadet*
TECHNOLOGY

A specially developed geometry inside the mower housing ensures all cuttings are transported through a **turbo tunnel** into the grass catcher. Improving mowing performance because no more cuttings get stuck or left on the lawn.



HIGH-PERFORMANCE HONDA GCV-ENGINE

Get the power you need when you need it for faster and smoother work. Honda engines run extremely smoothly – generating fewer vibrations and less noise (available on XM2 DR46 model).



ELECTRIC STARTER

The XM2 ER53e engine starts easily at a push of a button.



ROBUST DESIGN AND HIGH-QUALITY COMPONENTS

The single die-cast aluminium housing is ultra-robust: free of any screws that can come loose. Tough front and side bumpers protect the mower against obstacles.



XM2 DR46

SIMILAR TO PHOTO

NEW

Cutting width:	46 cm / 18"
Recommended area capacity:	750 m ² /h
Collecting volume:	65 l
Engine:	Honda GCV 160, recoil starter
Engine displacement:	160 cm ³
Drive:	Variable drive, 6 forward gears
Cutting height adjustment:	6 positions/central

Model no.: 12AQYADQ603



XM2 ER53e

SIMILAR TO PHOTO

NEW

Cutting width:	53 cm / 21"
Recommended area capacity:	950 m ² /h
Collecting volume:	75 l
Engine:	Cub Cadet 65 OHV ES, electric starter
Engine displacement:	196 cm ³
Drive:	Variable drive, 6 forward gears
Cutting height adjustment:	6 positions/central

Model no.: 12ARZA9A603

2

SELF-PROPELLED LAWNMOWERS

1

3

4

5

6

7

8

9



XM3 **ENDURO SERIES™**

STRONG FEATURES, EASY OPERATION.

The Cub Cadet XM3 is not just a regular lawnmower. It's a large-area mower. Thanks to the extremely large cutting width and high-performance engine, you can easily mow a large area in a short time. A combination of strength and efficiency makes your work easy.

Cover more ground with less effort, thanks to the strongest wide-area lawnmower your lawn has ever seen. You'll find incredible strength in its powerful engine. You'll experience ultimate efficiency thanks to an 84 cm (33") steel cutting deck and zero-turn manoeuvrability.

The variable four speed system allows you to set your speed based on the environment and personal preference. Front caster wheels enable easy manoeuvrability, while large rear pneumatic wheels grip the ground for superior traction over uneven terrain.

XM3 – SPECIAL ADVANTAGES



HIGH-PERFORMANCE ENGINE

The reliable B&S OHV E-Start engine provides enough power even for long grass and on inclines.



CENTRAL CUTTING HEIGHT ADJUSTMENT

The cutting height can be adjusted in eight stages from 25-100 mm using one central lever.



ELECTRIC STARTER

Starts the engine comfortably at the turn of a key.

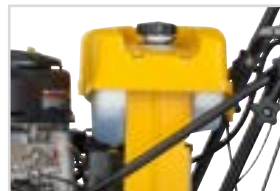

LARGE PETROL TANK WITH A CAPACITY OF 7.5 L

Saves time and easily mows 2,000 m³/hour.

STRONG FEATURES FOR THE LONG RUN



ELECTRIC START
Easy and safe electronic key start

STRONG ENGINE
The reliable B&S OHV e-start engine provides continual power, even on high grass and up slopes

2-in-1

0 ZERO-TURN

Swivelling front wheels and pneumatic rear wheels

LARGE FUEL TANK
Cut up to 2,000 square metres per hour, meaning more time mowing and less time refuelling

CENTRAL CUTTING HEIGHT ADJUSTMENT
The cutting height can be adjusted in eight stages from 25-100 mm using one central lever

WIDE CUT DECK
84 cm / 33" steel wide cut deck with 2-in-1 cutting option

XM3 KR84es

Cutting width:	84 cm / 33"
Engine:	B&S 3105 Series, 344 cm ³ , Electric start
Rated power:	6.5 kW / 2,900 min ⁻¹
Drive:	Variable Speed

Model no.: 12AE764U603

2

SELF-PROPELLED LAWNMOWERS

1

3

4



5

6

7

8

9

	XM1 DR46	XM1 ER53		
ENGINE	Engine type	Cub Cadet 55 OHV	Cub Cadet 65 OHV	
	Engine displacement	159 cm ³	196 cm ³	
	Rated power	2.5 kW / 2,800 min ⁻¹	3.3 kW / 2,800 min ⁻¹	
	Engine start	Pull	Pull	
	Tank volume (capacity)	1.0 l	1.0 l	
DRIVE SYSTEM	Drive	Rear-wheel-drive	Rear-wheel-drive	
	Number of speeds	Single	Single	
	Speed (max)	- 3.6 km/h	- 3.6 km/h	
	Mowing area in m ² /h	750	950	
	Cutting deck (material)	Aluminium	Aluminium	
CUTTING SYSTEM	Cutting width	46 cm / 18"	53 cm / 21"	
	Cutting options	3-in-1 Option	3-in-1 Option	
	Cutting height adjustment	6 Positions/central	6 Positions/central	
	Cutting height (min-max)	20-90 mm	20-90 mm	
	Grass catcher	Standard	Standard	
	Mulching plug	Optional	Optional	
	Side discharge	-	-	
	Rear discharge without collector	Standard	Standard	
	BAGGING	Grass catcher type	Soft bag with dustblocker	Soft bag with dustblocker
		Grass catcher capacity	65 l	75 l
Bag full indicator		Standard	Standard	
WHEELS	Wheels (F/R)	200 mm / 240 mm (8" / 9.5")	200 mm / 240 mm (8" / 9.5")	
	Double ball bearings	Standard	Standard	
	Washing nozzle	Standard	Standard	
COMFORT	Handle type	VIBEX soft grip	VIBEX soft grip	
	Foldable handle	Standard	Standard	
	Height adjustable handle	Standard	Standard	
DIMENSIONS	LpA/LwA/LwAg (dB)	84 / 94 / 96	89 / 96 / 98	
	Dimensions (L/W/H)	117 cm / 53 cm / 50 cm	117 cm / 60 cm / 50 cm	
	Weight net	48 kg	52 kg	
	Model number	12A-YAKC603	12A-ZAJ4603	
EAN	 4 008423 882049	 4 008423 882070		

XM2 DR46	XM2 ER53e	XM3 KR84es
Honda GCV 160	Cub Cadet 65 OHV ES	B&S 3105 Series
160 cm ³	196 cm ³	344 cm ³
2.5 kW / 2,800 min ⁻¹	3.3 kW / 2,800 min ⁻¹	6.5 kW / 2,900 min ⁻¹
Pull	Electric Start	Electric Start
1.0 l	1.1 l	7.5 l
VarioSpeed	VarioSpeed	VarioSpeed
6	6	4 fwd./1 rev.
2.8 km/h – 4.5 km/h	2.8 km/h – 4.5 km/h	0 – 3.6 km/h
750	950	2,000
Aluminium	Aluminium	Steel
46 cm / 18"	53 cm / 21"	84 cm / 33"
3-in-1 Option	3-in-1 Option	2-in-1
6 Positions/central	6 Positions/central	8 Positions/central
20–90 mm	20–90 mm	25–100 mm
Standard	Standard	-
Optional	Optional	Standard
-	-	Standard
Standard	Standard	-
Soft bag with dustblocker	Soft bag with dustblocker	-
65 l	75 l	-
Standard	Standard	-
200 mm / 240 mm (8" / 9.5")	200 mm / 240 mm (8" / 9.5")	200 mm / 400 mm (8" / 16")
Standard	Standard	Standard
Standard	Standard	Standard
VIBEX soft grip	VIBEX soft grip	Standard
Standard	Standard	Standard
Standard	Standard	-
84 / 94 / 96	89 / 96 / 98	88 / 98 / 100
117 cm / 53 cm / 50 cm	117 cm / 60 cm / 50 cm	170 cm / 112 cm / 106 cm
48 kg	54 kg	120 kg
12AQYADQ603	12ARZA9A603	12AE764U603
 4 008423 882094	 4 008423 882117 >	 4 008423 835243

2

LAWNMOWER SPECIFICATIONS

1

3

4

5

6

7

8

9





**COMPACT AND
AGILE,
LIKE NEVER
BEFORE.**

MINI-RIDERS

The Cub Cadet Mini-Riders deliver the same strength, durability and perfect cut as our larger lawn tractors, just in a more compact design. Plus, you have the choice between two models with transmatic and three models with hydrostatic drive. The Cub Cadet Mini-Riders are more than just compact, they are comfortable, convenient and unmatched in quality.

LR1 FORCE SERIES



TRULY UNIQUE. TRULY COMPACT.

Modern design, versatility and comfortable mowing are just three of the many assets of our Mini-Riders. These compact and manoeuvrable mowers are equipped with electric start, adjustable soft grip steering wheel and a powerful and smooth 420cm³ Cub Cadet engine.

Thanks to space-saving design, these modern ride-on mowers do not need much more space in your garage than a conventional lawnmower and are perfect for getting through narrower garden gates. The LR1 Mini-Riders feature a transmatic transmission allowing you to shift-on-the-go.

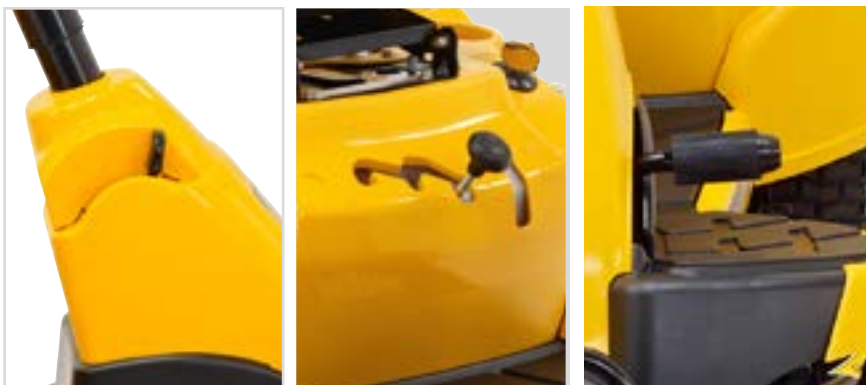

TRANSMATIC TRANSMISSION

The transmatic transmission allows shift-on-the-go speed control. Simply choose the driving direction, set the desired basic speed and start on the LR1 Mini-Riders, you have the choice of six forward and six reverse speeds.



76 CM / 30" MOWING DECK

The Mini-Rider cutting deck is wide enough to cut up to 3,000m² in an hour, but small enough to fit through most garden gates. With options to collect, discharge or mulch the grass clippings, the Mini-Rider mowing deck can handle it all.



LARGE GRASS BAG

Rear discharge models are equipped with a grass bag as standard. The large grass bag has a hard top, soft handle grips and a handy bag full indicator. Conveniently it can be emptied from the drivers seat, saving time and effort. Available as an optional accessory on the side discharge models.



CUTTING HEIGHT ADJUSTMENT & PTO CLUTCH

The cutting height can easily be adjusted through five positions from 38 mm to 95 mm and with the individual deck clutch lever the cutting deck can be switched on and off. Both levers are conveniently located on the right side of the seat.

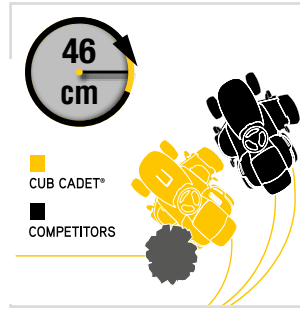

Narrow turning radius

Cub Cadet LR Mini-Riders have a tight turning radius of only 46 cm (18").



STEP-THROUGH FRAME

A sturdy step through frame makes getting on and off the Mini-Rider quick and easy. All the controls are easily to hand once seated and the soft rubber foot pads and foot rest make the Mini-Rider a comfortable place to be.



LARGE TYRES

Large pneumatic tyres provide comfort, safety and confidence around the garden and are gentle to your lawn.



LR1 NR76

Cutting width:	76 cm / 30"
Engine:	Cub Cadet OHV, 420 cm ³
Rated power:	8.2 kW / 2,500 min ⁻¹
Drive:	Transmatic 6 Speed

Model no.: 13C226HD603



LR1 NS76

Cutting width:	76 cm / 30"
Engine:	Cub Cadet OHV, 420 cm ³
Rated power:	8.2 kW / 2,650 min ⁻¹
Drive:	Transmatic 6 Speed

Model no.: 13C226JD603

1

2

3

MINI-RIDERS

4

5

6

7

8

9

LR2 FORCE SERIES



THE SIZE YOU NEED, WITH THE PERFORMANCE YOU WANT.

The LR2 Mini-Riders deliver the same strength, durability and cutting performance as our larger lawn tractors, just in a more compact design. Benefitting from smooth hydrostatic transmissions, integrated LED lighting and reverse mowing technology, the LR2 Mini-Riders are fully equipped and easy to handle. With optimum control, cutting edge technology and a choice of cutting options, these Mini-Riders will help you get the job done quickly and in comfortable style.



INTELLIGENT PARKING ASSISTANCE (IPA)

With the innovative IPA system, it is much easier to park your Mini-Rider in your garage or shed when you have finished.

This intelligent parking system decreases the speed of your Mini-Rider by 50%, giving you a much safer feeling and more precision and control when reversing.

RevTEK TECHNOLOGY

Reverse Mowing Technology. An ingenious system giving you the ability to mow in reverse when required. Simply turn the key to the yellow position and push the triangle button.

HYDROSTATIC DRIVE SYSTEM

The LR2 models are equipped with a luxurious hydrostatic drive system.

The hydrostatic transmission means you can control velocity as well as the forward and reverse speed continuously.

No clutching or shifting is required, offering a very smooth and controlled drive.



ADJUSTABLE SEAT

The deluxe comfort seat is adjustable, so it is simple to find your perfect seating position to enjoy mowing the lawn.



LED LIGHTS

Mow from dawn to dusk safely with the reassurance that when the light fades, you can still get the job done with effective LED lights (not on LR2 FR60).



OPTIONAL COLLECTION BAG

Available as an accessory, this 115L grass bag attaches to side discharge Mini-Riders. NOTE: Will also require high lift bagging blade 742-05116. Model no.: 19A300140EM



FRONT BUMPER

Helps to prevent damage to your Mini-Rider and provides greater durability – available on the rear collection Mini-Riders.



SUPER GRIP PEDALS

The super grip pedals on our Mini-Riders are soft, comfortable and provide excellent grip to ensure you are always in control, even in bad conditions.



TELESCOPING STEERING COLUMN

The steering column can be adjusted to suit your personal height and a soft-grip steering wheel, makes the Mini-Rider a comfortable place to be.



LR2 FR60

SIMILAR TO PHOTO

NEW

Cutting width:	60 cm / 24"
Engine:	Briggs & Stratton 223 cm ³
Rated power:	3.7 kW / 2,800 min ⁻¹
Drive:	Hydrostatic

Model no.: 13A521SC603



LR2 NR76

Cutting width:	76 cm / 30"
Engine:	Cub Cadet OHV, 420 cm ³
Rated power:	8.2 kW / 2,900 min ⁻¹
Drive:	Hydrostatic

Model no.: 13B221HD603



LR2 NS76

Cutting width:	76 cm / 30"
Engine:	Cub Cadet OHV, 420 cm ³
Rated power:	8.2 kW / 2,650 min ⁻¹
Drive:	Hydrostatic

Model no.: 13A221JD603

3

MINI-RIDERS

1

2

4



5

6

7

8

9

	LR1 NS76	LR1 NR76	
ENGINE	Engine type	Cub Cadet OHV	Cub Cadet OHV
	Engine displacement	420 cm ³	420 cm ³
	Rated power	8.2 kW / 2,650 min ⁻¹	8.2 kW / 2,500 min ⁻¹
	Cylinders	Single	Single
	Tank volume (capacity)	4.9 l	4.9 l
DRIVE SYSTEM	Lubrication	Fully pressurised with automotive-style oil pump spin-on oil filter	Fully pressurised with automotive-style oil pump spin-on oil filter
	Transmission	Transmatic 6 Speed	Transmatic 6 Speed
	Speeds	6 (f/r), shift-on-the-go	6 (f/r), shift-on-the-go
CUTTING SYSTEM	Control	Foot pedal control	Foot pedal control
	Mowing area in m ² /h	3,000	2,500
	Cutting width	76 cm / 30 "	76 cm / 30 "
	Cutting height (min-max)	38–95 mm	38–95 mm
	Cutting options	3-in-1 Option	3-in-1
	Number of blades	1	1
	Deck engagement	Manual lever control	Manual lever control
DISCHARGE SYSTEM	Deck height positions	5	5
	Wash nozzle / mulching plug	Included / Standard	Included / Standard
	Bag (capacity) / accessory no	Optional 115 l (without blades) (19A30014OEM)	200 l
FRAME	Bag lever / Hardtop	–/–	over 2 fixed grips / –
	Bag full indicator / grass deflector	– / Standard	Standard / Standard
ELECTRICAL SYSTEM	Front axle	Steel	Steel
	Front bumper	–	Standard
	Turning radius	46 cm / 18 "	46 cm / 18 "
	Wheel size (front/rear)	13" x 5" / 16" x 6.5"	13" x 5" / 16" x 6.5"
	Wheel bearings	Sleeve bearings	Sleeve bearings
COMFORT	Easy entry frame	Standard	Standard
	Battery	12 V Heavy-Duty	12 V Heavy-Duty
	Headlights	–	–
DIMENSIONS	Safety systems	Neutral start, operator presence, brake pedal lock	Neutral start, operator presence, brake pedal lock
	Seat type	Deluxe Comfort Seat	Deluxe Comfort Seat
	Seat adjustment	Screw	Screw
	Steering wheel	Comfort	Comfort
DIMENSIONS	Mow in reverse (RevTEK™)	–	–
	Battery charger	(196-967-678)	(196-967-678)
	LpA / LwA / LwAg (dB)	88 / 98 / 100	88 / 98 / 100
	Vibration value body/ (K-factor)	1 / 0.5 m/s ²	1 / 0.5 m/s ²
	Dimensions (L/W/H)	157 cm / 85 cm / 112 cm	225 cm / 86 cm / 112 cm
	Weight net	127 kg	145 kg
	Model number	13C226JD603	13C226HD603
	EAN	 4 008423 875522	 4 008423 875515

LR2 FR60	LR2 NS76	LR2 NR76
Briggs & Stratton 1000 Series	Cub Cadet OHV	Cub Cadet OHV
223 cm ³	420 cm ³	420 cm ³
3.7 kW / 2,800 min ⁻¹	8.2 kW / 2,650 min ⁻¹	8.2 kW / 2,500 min ⁻¹
Single	Single	Single
1.2 l	4.9 l	4.9 l
Dura-lube splash lubrication	Fully pressurised with automotive-style oil pump spin-on oil filter	Fully pressurised with automotive-style oil pump spin-on oil filter
Hydrostatic	Hydrostatic	Hydrostatic
Infinitely variable	Infinitely variable	Infinitely variable
Foot pedal control	Foot pedal control	Foot pedal control
1,500	3,000	2,500
60 cm / 24 "	76 cm / 30 "	76 cm / 30 "
38-95 mm	38-95 mm	38-95 mm
3-in-1 Option	3-in-1 Option	3-in-1
1	1	1
Manual lever control	Manual lever control	Manual lever control
5	5	5
Standard / Optional	Included / Standard	Included / Standard
150 l	Optional (without blades) (19A30014OEM)	200 l
-/-	-/-	over 2 fixed grips / plastic
- / Optional	- / Standard	Standard / Standard
Steel	Steel	Steel
-	-	Standard
46 cm / 18 "	46 cm / 18 "	46 cm / 18 "
13" x 5" / 16" x 6.5"	13" x 5" / 16" x 6.5"	13" x 5" / 16" x 6.5"
Sleeve bearings	Sleeve bearings	Sleeve bearings
Standard	Standard	Standard
12 V Heavy-Duty	12 V Heavy-Duty	12 V Heavy-Duty
-	LED	LED
Neutral start, operator presence, brake pedal lock	Neutral start, operator presence, brake pedal lock	Neutral start, operator presence, brake pedal lock
Deluxe Comfort Seat	Deluxe High Comfort Seat	Deluxe High Comfort Seat
Screw	Screw	Screw
Comfort	Comfort	Comfort
-	Standard	Standard
(196-967-678)	(196-967-678)	(196-967-678)
86 / 96 / 98	88 / 98 / 100	88 / 98 / 100
1 / 0.5 m/s ²	1 / 0.5 m/s ²	1 / 0.5 m/s ²
192 cm / 83 cm / 112 cm	157 cm / 85 cm / 112 cm	225 cm / 86 cm / 112 cm
189 kg	127 kg	172 kg
13A521SC603	13A221JD603	13B221HD603
 4 008423 883374 >	 4 008423 875508 >	 4 008423 865493 >

3

MINI-RIDERS SPECIFICATIONS

1

2

4

5

6

7

8

9





COMFORT AND EFFICIENCY, PERFECTLY COMBINED.

LAWN TRACTORS

Cub Cadet lawn tractors deliver the perfect mowing experience, cut after cut, season after season.

Equipped with powerful engines and built on durable strong steel frames with hard-wearing components, Cub Cadet lawn tractors are made to work. Our line up of lawn tractors have been ergonomically designed for user comfort, honed to ensure incredibly responsive handling and made to deliver exceptional cut and collecting performance.

Power, strength, comfort and efficiency in every detail!



LT1 LAWN TRACTORS, A STEP UP IN POWER AND PERFORMANCE.

With a lawn tractor from the FORCE SERIES, mowing lawns becomes an even more efficient and effective gardening experience. The decks on lawn tractors are typically six inches wider than those found on Mini-Riders and over 16" wider in comparison to a regular lawnmower. With a wider cutting deck and more powerful engines not only can you cut more, but you can mow at a speed which is 2 – 3 times faster, saving you time and effort.

The LT Series of lawn tractors deliver perfect mowing performance, exceptional cutting and bagging with incredibly responsive handling.



TRANSMATIC TRANSMISSION

Allows shift-on-the-go speed control. Simply choose the driving direction, set the desired basic speed with the speed shift lever and release the brake/clutch pedal. Push the pedal to slow down or press it all the way forward to stop. By releasing the brake pedal, the tractor automatically resumes to your preset speed.

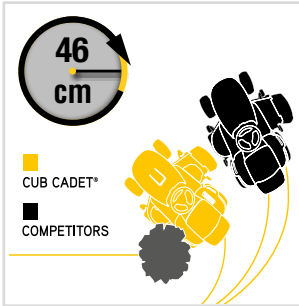

Narrow turning radius

Cub Cadet LT lawn tractors have a tight turning radius of only 46 cm (18"). Great for getting around shrubs and garden paths.



The LT1 NR92 and all LT2 and LT3 rear discharge models feature a sizeable grass bag, made of durable fabric with a hard top. The fabric allows for flexibility and the airflow helps ensure the grass clippings pass directly into the collection bag for perfect collection. The hard top on the grass bag controls any dust and reduces any noise from the collection process.



DIRECT COLLECT®

All Cub Cadet rear discharge tractors feature the innovative Direct Collect® system. This innovative design helps to scoop up grass, leaves and debris into the large capacity collector to minimise blockages from wet clippings and the clippings are transported into the collector in the shortest way. So, whatever the weather you can use a Direct Collect® garden tractor to give you a perfect cut and finish every time.

UK SPECIAL EDITION



LT1 NR76

Cutting width:	76 cm / 30 "
Engine:	Cub Cadet OHV, 420 cm ³
Rated power:	7.0 kW / 2,500 min ⁻¹
Drive:	Transmatic

Model no.: 13H276DC603



LT1 NR92

Cutting width:	92 cm / 36 "
Engine:	Cub Cadet OHV, 420 cm ³
Rated power:	7.8 kW / 2,750 min ⁻¹
Drive:	Transmatic 6 Speed

Model no.: 13J276DE603



LT1 NS96

Cutting width:	96 cm / 38 "
Engine:	Cub Cadet OHV, 420 cm ³
Rated power:	7.8 kW / 2,800 min ⁻¹
Drive:	Transmatic 6 Speed

Model no.: 13I276DF603



LT2 FORCE SERIES

LT2 LAWN TRACTORS, A SMOOTH AND EFFICIENT CUT.

The LT2 lawn tractor models raise the bar for effortless mowing, with smooth driving hydrostatic transmissions operated either by foot or hand controls. They are ideally suited for areas between ½ and 1½ acres in size and the 3-in-1 cutting option enables you to select the best discharge approach to meet your specific needs.

A small turning radius of 46cm enables manoeuvrability around plants and shrubs with ease and the powerful Cub Cadet OHV engine delivers the power and performance to get the job done quickly and efficiently.

These lawn tractors make garden maintenance easy and enjoyable.



HYDROSTATIC TRANSMISSION

The particular feature of the hydrostatic transmission is that you can control velocity as well as the forward and reverse speed continuously. No clutching or shifting is required. It offers a very smooth and precise drive. The LT2 NR92 rear discharge lawn tractor is foot-pedal controlled and the LT2 NS96 is controlled by hand levers.



CUTTING HEIGHT ADJUSTMENT
5-position height adjustment easily changes the cutting height (30 - 95 mm).



STEEL FRAME
All LT tractor frames are made of strong, steel construction which is fully welded and powder coated for added durability.



Powerful and reliable Cub Cadet engine – providing commercial-grade features and reduced emissions.



FRONT AXLE
Pivoting steel or cast iron front axle. This keeps all four wheels on the ground even on uneven surface.



DIRECT COLLECT®
A large turbo fan, coupled with a heavy duty blade physically throws and blows grass cuttings, leaves and other debris directly into the fabric grass collector in the shortest, most efficient way.



PIVOTING ONE-PIECE BONNET
The entire bonnet can be removed within seconds without the need for tools, allowing for easy maintenance.



LT2 NR92

Cutting width:	92 cm / 36 "
Engine:	Cub Cadet OHV, 420 cm ³
Rated power:	7.3 kW / 2,600 min ⁻¹
Drive:	Hydrostatic

Model no.: 13I271DE603



LT2 NS96

Cutting width:	96 cm / 38 "
Engine:	Cub Cadet OHV, 420 cm ³
Rated power:	7.8 kW / 2,800 min ⁻¹
Drive:	Hydrostatic

Model no.: 13I279DF603

LT3 FORCE SERIES



LT3 LAWN TRACTORS, AN EXPERIENCE IN VERSATILITY

The LT3 lawn tractors are extraordinarily versatile with the ability to cover large grounds quickly and efficiently owing to larger cutting decks, powerful Briggs and Stratton Engines and benefiting from RevTEK™ technology. RevTEK™ is an innovative technology allowing you to mow in reverse, enhancing the usability of a lawn tractor.



HYDROSTATIC TRANSMISSION

The particular feature of the hydrostatic transmission is that you can control velocity as well as the forward and reverse speed continuously. No clutching or shifting is required. It offers a very smooth and precise drive. The LT3 PR105 rear discharge lawn tractors are foot-pedal controlled and the LT3 PS107 is controlled by a hand lever.

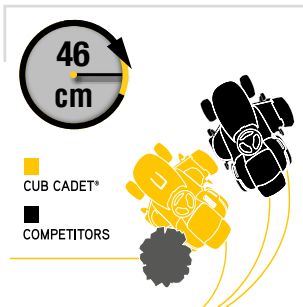

NARROW TURNING RADIUS
Cub Cadet LT lawn tractors have a tight turning radius of only 46 cm (18"). This means improved manoeuvrability, increased stability and added traction - especially on banks and hills.



RevTEK™ TECHNOLOGY
RevTEK™ – Reverse Mowing Technology: Allows you to cut in reverse. *LT3 models only.*

DIRECT COLLECT®
Effective and efficient clippings collection



ADJUSTABLE SEAT
Quick adjustable lever on a high back seat

COMFORT STEERING WHEEL
Comfortable 3-spoke soft grip steering wheel



BRIGGS & STRATTON ENGINE
Powerful V-Twin Intek engine with reduced emissions

CUTTING HEIGHT ADJUSTMENT
Five positions from 30mm – 95mm

HYDROSTATIC TRANSMISSION
Ensures a smooth and exacting drive



LT3 PR105

Cutting width:	105 cm / 41 "
Engine:	B&S, Intek V-Twin, 656 cm ³
Rated power:	10.8 kW / 2,600 min ⁻¹
Drive:	Hydrostatic

Model no.: 13HT71DN603





LT3 PS107





Cutting width:	107 cm / 42 "
Engine:	B&S, Intek V-Twin, 656 cm ³
Rated power:	12.5 kW / 2,800 min ⁻¹
Drive:	Hydrostatic

Model no.: 13HT79DG603

LAWN TRACTORS

1
2
3
4
5
6
7
8
9

	LT1 NR76	LT1 NR92	LT1 NS96	
ENGINE	Engine type	Cub Cadet OHV	Cub Cadet OHV	Cub Cadet OHV
	Engine displacement	420 cm ³	420 cm ³	420 cm ³
	Rated power	7.0 kW / 2,500 min ⁻¹	7.8 kW / 2,750 min ⁻¹	7.8 kW / 2,800 min ⁻¹
	Cylinders	Single	Single	Single
	Tank volume (capacity)	3.8 l	3.8 l	3.8 l
DRIVE SYSTEM	Lubrication	Fully pressurised with automotive - style oil pump spin-on oil filter	Fully pressurised with automotive - style oil pump spin-on oil filter	Fully pressurised with automotive - style oil pump spin-on oil filter
	Transmission	Transmatic 7 Speed	Transmatic 6 Speed	Transmatic 6 Speed
	Speeds	7 (f/r), shift-on-the-go	6 (f/r), shift-on-the-go	6 (f/r), shift-on-the-go
	Control	Foot pedal control	Foot pedal control	Foot pedal control
CUTTING SYSTEM	Cruise control	-	-	-
	Mowing area in m ² /h	2,500	3,500	4,000
	Cutting width	76 cm / 30 "	92 cm / 36 "	96 cm / 38 "
	Cutting height (min-max)	30-95 mm	30-95 mm	30-95 mm
	Cutting options	2-in-1	3-in-1 Option	3-in-1 Option
	Number of blades	1	2	2
	Deck engagement	Manual lever control	Manual lever control	Manual lever control
	Deck height positions	5	5	5
	Deck wheels	-	2	2
	Wash nozzle / mulching plug	-	- / (196-749A678)	- / (OEM-190A116)
DISCHARGE SYSTEM	Bag (capacity) / accessory no	200 l	240 l	(OEM-190-180A)
	Bag lever / hardtop	-/-	Telescopic handle / Plastic	-/-
	Bag full indicator/grass deflector	- / Standard	- / (196-750A678)	- / Standard
FRAME	Front axle	Steel	Steel	Steel
	Front bumper	(OEM-196B603)	(OEM-196B603)	(OEM-196B603)
	Turning radius	46 cm / 18"	46 cm / 18"	46 cm / 18"
	Wheel size (front/rear)	13" x 5" / 18" x 6.5"	15" x 6" / 18" x 9.5"	15" x 6" / 20" x 8"
	Wheel bearings	Sleeve bearings	Sleeve bearings	Sleeve bearings
	Easy entry frame	Standard	Standard	Standard
ELECTRICAL SYSTEM	Battery	12 V Heavy-Duty	12 V Heavy-Duty	12 V Heavy-Duty
	Headlights	Standard	Standard	Standard
	System monitor package	-	-	-
	Safety systems	Neutral start, operator presence, brake pedal lock	Neutral start, operator presence, brake pedal lock	Neutral start, operator presence, brake pedal lock
COMFORT	Seat type	Medium back	Low back	Low back
	Seat adjustment	Screw	Screw	Screw
	Steering wheel	Comfort	Comfort	Comfort
	Tool box/12 V plug	-/-	-/-	-/-
	Mow in reverse (RevTEK™)	Standard	-	-
DIMENSIONS	Battery charger	(196-967-678)	(196-967-678)	(196-967-678)
	LpA / LwA / LwAg (dB)	88 / 98 / 100	88 / 98 / 100	88 / 98 / 100
	Vibration value body/ (K-factor)	1 / 0.5 m/s ²	1 / 0.5 m/s ²	1 / 0.5 m/s ²
	Dimensions (L/W/H)	225 cm / 91 cm / 103 cm	225 cm / 99 cm / 103 cm	170 cm / 107 cm / 100 cm
	Weight net	150 kg	195 kg	150 kg
Model number	13H276DC603	13J276DE603	13I276DF603	
EAN	 4 008423 861990 >	 4 008423 873788	 4 008423 873795	

LT2 NR92	LT2 NS96	LT3 PR105	LT3 PS107
Cub Cadet OHV	Cub Cadet OHV	B&S Intek	B&S Intek
420 cm ³	420 cm ³	656 cm ³	656 cm ³
7.3 kW / 2,600 min ⁻¹	7.8 kW / 2,800 min ⁻¹	10.8 kW / 2,600 min ⁻¹	12.5 kW / 2,800 min ⁻¹
Single	Single	V-Twin	V-Twin
3.8 l	3.8 l	3.8 l	3.8 l
Fully pressurised with automotive - style oil pump spin-on oil filter	Fully pressurised with automotive - style oil pump spin-on oil filter	Fully pressurised with automotive - style oil pump spin-on oil filter	Fully pressurised with automotive - style oil pump spin-on oil filter
Hydrostatic	Hydrostatic	Hydrostatic	Hydrostatic
Infinitely variable	Infinitely variable	Infinitely variable	Infinitely variable
Dual direction foot pedal control	Manual lever control	Dual direction foot pedal control	Manual lever control
-	-	-	-
3,500	4,000	4,500	5,500
92 cm / 36 "	96 cm / 38 "	105 cm / 41 "	107 cm / 42 "
30-95 mm	30-95 mm	30-95 mm	30-95 mm
3-in-1 Option	3-in-1 Option	3-in-1 Option	3-in-1 Option
2	2	2	2
Manual lever control	Manual lever control	Manual lever control	Manual lever control
5	5	5	5
2	2	2	2
- / (196-749A678)	- / (OEM-190A116)	Standard / (196-749A678)	Standard / Standard
240 l	(OEM-190-180A)	240 l	(OEM-190-180A)
Telescopic handle/Plastic	-/-	Telescopic handle/Plastic	-/-
- / (196-750A678)	- / Standard	- / (196-750A678)	- / Standard
Steel	Steel	Cast-iron	Cast-iron
(OEM-196B603)	(OEM-196B603)	Standard	Standard
46 cm / 18"	46 cm / 18"	46 cm / 18"	46 cm / 18"
15" x 6" / 18" x 9.5"	15" x 6" / 20" x 8"	15" x 6" / 18" x 9.5"	15" x 6" / 20" x 8"
Sleeve bearings	Sleeve bearings	Sleeve bearings	Sleeve bearings
Standard	Standard	Standard	Standard
12 V Heavy-Duty	12 V Heavy-Duty	12 V Heavy-Duty	12 V Heavy-Duty
Standard	Standard	Standard	Standard
-	-	-	-
Neutral start, operator presence, brake pedal lock	Neutral start, operator presence, brake pedal lock	Neutral start, operator presence, brake pedal lock	Neutral start, operator presence, brake pedal lock
Low back	Low back	High back	High back
Screw	Screw	Quick adjuster lever	Quick adjuster lever
Comfort	Comfort	Comfort	Comfort
-/-	-/-	-/-	-/-
-	-	Standard	Standard
(196-967-678)	(196-967-678)	(196-967-678)	(196-967-678)
88 / 98 / 100	88 / 98 / 100	88 / 98 / 100	88 / 98 / 100
1 / 0.5 m/s ²	1 / 0.5 m/s ²	1 / 0.5 m/s ²	1 / 0.5 m/s ²
225 cm / 99 cm / 103 cm	170 cm / 107 cm / 100 cm	225 cm / 110 cm / 103 cm	170 cm / 115 cm / 100 cm
195 kg	150 kg	198 kg	175 kg
13I271DE603	13I279DF603	13HT71DN603	13HT79DG603
			
4 008423 872477	4 008423 872507	4 008423 866384	4 008423 866391

4

LAWN TRACTOR SPECIFICATIONS

1

2

3

5

6

7

8

9

Cub Cadet®

ENDURO SERIES™

XT

ENDURO SERIES™

[55] XT LAWN TRACTORS





**STRONG,
POWERFUL
AND AGILE.**

XT SERIES

The XT ENDURO SERIES offers strength, efficiency and effectiveness like never before. Powerful performance, agility and market leading innovations, the XT ENDURO SERIES are the best lawn tractors Cub Cadet has ever built.

Designed for ambitious garden lovers, the XT2 models boast the tightest turning circle on the market and the XT2 and XT3 models come with the Cub Cadet Bluetooth® App allowing you to review the maintenance information of your tractor on your smartphone. Differential lock on the XT3 models ensures the optimum traction on tough and sloping terrain.

Electronic fuel injection (EFI) gives you reliable performance and power with significant fuel efficiency. Setting new standards in comfort and strength the Cub Cadet EFI engine uses up to 25% less fuel versus standard carburetted engines.

Exceed your expectations.

THE TOP 5 MARKET LEADING FEATURES OF THE XT LAWN TRACTORS.

DISCOVER THE MOST INNOVATIVE TRACTORS WE HAVE EVER BUILT.

1.

MARKET-LEADING CUTTING, COLLECTING & MULCHING SYSTEM

Optimise your mowing results in minimum time.



THE SMALLEST TURNING CIRCLE ON THE MARKET

Unbeatable efficiency even in confined spaces thanks to innovative xTreme "Tight-Turn" technology.

2.

3.

ULTRA-STURDY, CORROSION-RESISTANT FRAME

Ultra-rigid frame for top durability.



PERFECTLY MATCHED TRANSMISSION AND ENGINE POWER

Optimal drive power and the most fuel efficient engine in its class.

4.

5.

ULTRA-RELIABLE V-BELT DESIGN

Improved V-belt design reduces belt tension ensuring longer belt life. The XT2 PS117i & XT3 QS137 tractors are also equipped with a fabricated mowing deck (see photo on the right).



CUB CADET APP – THE SMART WAY TO STAY CONNECTED

Want to know when the next oil change is due, when the blades need to be replaced, or how many operating hours your XT lawn tractor has clocked up? Simply download the Cub Connect Bluetooth® app from the app store. Use your smartphone to view the operating state and any maintenance information about your Cub Cadet XT2 or XT3 lawn tractor. You can even charge your phone while mowing using the multifunction socket on these models.



OPERATORS MANUAL

Direct online access to the manual for your XT lawn tractor.



OPERATING HOUR COUNTER

The operating hour counter tells you how many hours your XT lawn tractor has worked.



MAINTENANCE SCHEDULES

Various maintenance schedules inform you how many operating hours remain until the oil, air filter and blades need changing. You can also read off the battery charge status here.

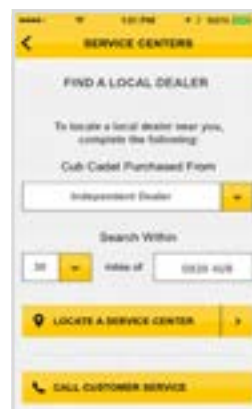

LOCAL DEALERSHIPS

Find out here where your nearest Cub Cadet dealership is.

4

LAWN TRACTORS

1

2

3

5

6

7

8

9

THE CUB CADET ENGINE – DESIGNED FOR EFFICIENCY.



EXPERIENCE ALL THE PROVEN BENEFITS OF EFI TECHNOLOGY THAT HAVE ONLY BEEN AVAILABLE IN THE COMMERCIAL LANDSCAPING INDUSTRY – UNTIL NOW.

- Lower fuel costs (uses up to 25% less than carburetor engines that deliver comparable performance) saving you both time and money when you refuel.
- Large engine displacement for miles of mowing power: 679 cm³.
- Engine no longer requires a manual choke. Simply take a seat, push the start button and get mowing.
- Improved driving characteristics (cold running performance, power consumption, no afterburning or continued running).
- Less servicing required as no carburetor to drain, saving costs on maintenance.
- Eco-friendly due to reduced emissions.
- Simple troubleshooting and diagnostic system for direct fuel injection lets dealers service models faster.

THE FOLLOWING XT MODELS FEATURE THE CUB CADET ENGINE WITH DIRECT FUEL INJECTION: XT2 PR106ie, XT2 PS117i



XT ENDURO SERIES™



**THE BEST TRACTORS WE HAVE EVER BUILT.
UNBEATABLE PERFORMANCE.
PURE POWER & EFFICIENCY FOR ALL CHALLENGES.
STRENGTH & QUALITY IN EVERY DETAIL.**



GRASS CATCHER WITH ELECTRONIC EMPTYING
At the touch of a button, the grass catcher lifts up and tips the cuttings out. Effortless, even when the catcher is full. Universal accessories available for all 2018 XT models.



POWERFUL KAWASAKI V-TWIN ENGINE
A two-cylinder engine for challenging terrain. Ultra-smooth running with low fuel consumption.

XT MODELS WITH KAWASAKI V-TWIN ENGINES:
XT2 PS107, XT2 PR95, XT2 QR106,
XT2 PS117, XT3 QS127, XT3 QS137,
XT3 QR95, XT3 QR106e.

THE NEW XT ENDURO SERIES™ AT A GLANCE

XT1
ENDURO SERIES

XT2
ENDURO SERIES

XT3
ENDURO SERIES



MARKET-LEADING CUTTING, COLLECTING AND MULCHING SYSTEM

- Thanks to the all-new grass collecting system and newly developed mower deck with rear or side-discharge options
- Larger capacity of grass bag than other Cub Cadet lawn tractors
- Best side discharging and collection bag characteristics on the market
- Pull-button electronic blade engagement

320 L BAG CAPACITY

360 L BAG CAPACITY

**HYDROSTATIC
V-BELT**

HYDROSTATIC POWER TRANSMISSION

Smooth drive system – simply put your foot on the pedal and go
Super stable belt-drive system for powerful drive force

POWERFUL CUB CADET ENGINE

Strong and reliable Cub Cadet engine

POWERFUL KAWASAKI V-TWIN ENGINE

The ideal engine with superior power and higher-torque for any terrain



**EFI ENGINE ON XT2 PR106IE & PS117i
FOR RELIABLE PERFORMANCE AND POWER
WITH SIGNIFICANT FUEL EFFICIENCY**



38 CM TIGHT TURN

Turning radius*
of 66 cm and more



**XT2 –
17 CM TIGHT TURN
xTREME**

Turning radius*
of 66 cm and more



38 CM TIGHT TURN

Turning radius*
of 66 cm and more



CUB CONNECT BLUETOOTH® APP

Get updates about status & inspection dates via smartphone

KEY START

PUSH-BUTTON START

FABRICATED DECK FOR XT2 PS117i AND XT3 QS137

MULTIPURPOSE CHARGER-SOCKET, FOR CHARGING MOBILE DEVICES

ANTI-DUST SYSTEM OPTIONAL

On rear discharge models

ANTI-DUST SYSTEM

Rear discharge with multi-layer dust apron included, protects against swirling grass and dirt

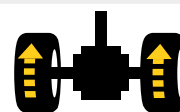

ALL-GROUND TRACTION SYSTEM

Optimum traction on tough terrain – thanks to mechanical differential lock

*To derive the turning radius of a lawn tractor, the position of the left rear wheel is marked and the tractor drives a 360 degree circle (on plain ground). Now you measure the distance between the mark and the actual position of the left rear wheel again. The half of this distance is the turning radius which is being shown in all product specifications.

LAWN TRACTORS

1
2
3
4
5
6
7
8
9

XT1™ ENDURO SERIES™



UNBELIEVABLE STRENGTH AND QUALITY

The Cub Cadet XT range, the latest generation of lawn tractors is setting benchmarks when it comes to power, performance and quality – offering you the ultimate package.

The XT1 lawn tractors are ideally equipped for mowing, collecting and transporting clippings and can be expanded with a range of accessories.

Powered by Cub Cadet, 547cm³ engines, the tractors in this range benefit from a smooth, hydrostatic drive system and a safe and efficient button blade start to activate the cutting blades.



ADJUSTABLE SEAT
Pure comfort for all users through 10 adjustable positions



PULL BUTTON BLADE START
Activate the cutting blades safely and more efficiently



LED HEADLIGHTS
Mow from dawn to dusk



WIDE ADJUSTABLE CUTTING HEIGHT RANGE
Quick and convenient, with the widest adjustment range on the market: 25mm-100mm



HYDROSTATIC DRIVE SYSTEM
Smooth drive system – simply put your foot on the pedal and go

3-in-1 OPTION

COLLECT, DISCHARGE AND OPTIONAL MULCHING

3-in-1 option means that you have the choice between collecting the clippings, or discharging them out the back. You also have the option to buy an additional mulch kit as an accessory.

— POWERED BY —
Cub Cadet

Powerful and reliable Cub Cadet engine – providing commercial-grade features and reduced emissions.



XT1 OS96

Cutting width:	96 cm / 38 "
Engine:	Cub Cadet single cylinder, 547 cm ³
Rated power:	12.9 kW / 2,400 min ⁻¹
Drive:	Hydrostatic

Model no.: 13A8A1CF603



XT1 OS107

Cutting width:	107 cm / 42 "
Engine:	Cub Cadet single cylinder, 547 cm ³
Rated power:	12.9 kW / 2,400 min ⁻¹
Drive:	Hydrostatic

Model no.: 13A8A1CS603



XT1 OR95

Cutting width:	95 cm / 38 "
Engine:	Cub Cadet single cylinder, 547 cm ³
Rated power:	12.9 kW / 2,400 min ⁻¹
Drive:	Hydrostatic

Model no.: 13B8A1CB603



XT1 OR106

Cutting width:	106 cm / 42 "
Engine:	Cub Cadet single cylinder, 547 cm ³
Rated power:	12.9 kW / 2,450 min ⁻¹
Drive:	Hydrostatic

Model no.: 13B8A1CR603



XT2™

ENDURO SERIES™

POWER AND PRECISION FOR GREATER CHALLENGES

The Cub Cadet XT2 models offer you an even higher level of power, control functions and durability. XT2 lawn tractors are the most agile in the XT range with Tight Turn xTreme, making them ideal for working on tough terrain and around busy gardens and obstacles. These innovative machines even have a Bluetooth® app called Cub Connect which keeps track of inspections and servicing.

The XT2 PR106ie and XT2 PS117i feature the EFI engine, giving you reliable performance and power with significant fuel efficiency.



XT2 PR95

Cutting width:	95 cm / 38 "
Engine:	Kawasaki, V-Twin, 603 cm ³
Rated power:	13.2 kW / 2,500 min ⁻¹
Drive:	Hydrostatic

Model no.: 13BGA1CB603



XT2 QR106

Cutting width:	106 cm / 42 "
Engine:	Kawasaki, V-Twin, 726 cm ³
Rated power:	15.8 kW / 2,500 min ⁻¹
Drive:	Hydrostatic

Model no.: 13BFA1CR603



**Bluetooth® CUB CONNECT
BLUETOOTH® APP**
Get updates about status & inspection dates via smartphone – and charge your phone with multifunction socket

Cub Cadet TIGHT TURN XTREME



Just 17 cm thanks to “Tight Turn xTreme” the tightest turning radius on the market. Innovative tight turn technology delivers unsurpassed capability in tight places.

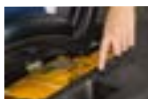

**ELECTRIC BAG
CATCHER**



XT2 PR106ie

SIMILAR TO PHOTO

NEW

Cutting width:	106 cm / 42"
Engine:	EFI Cub Cadet, V-TWIN dual cylinder, 679 cm ³
Collecting volume:	320 l, electric bag lift
Rated power:	16.5 kW / 2,150 cm ³
Drive:	Hydrostatic

Model no.: 13BZA1CN603



XT2 PS107

Cutting width:	107 cm / 42"
Engine:	Kawasaki, V-Twin, 603 cm ³
Rated power:	13.4 kW / 2,250 min ⁻¹
Drive:	Hydrostatic

Model no.: 13AGA1CS603



XT2 PS117

Cutting width:	117 cm / 46"
Engine:	Kawasaki, V-Twin, 603 cm ³
Rated power:	13.4 kW / 2,600 min ⁻¹
Drive:	Hydrostatic

Model no.: 13AGA1CT603

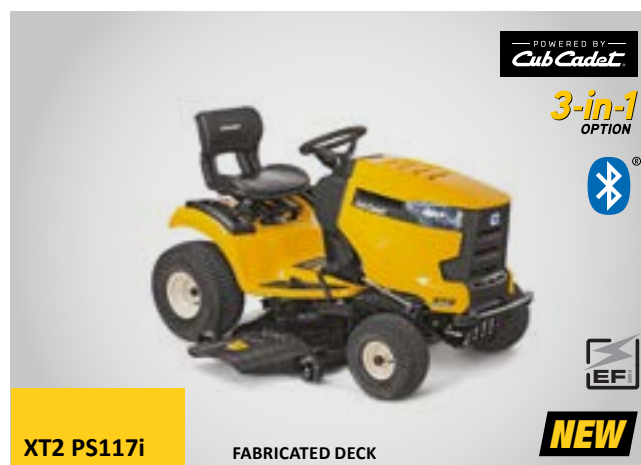

XT2 PS117i

FABRICATED DECK

NEW

Cutting width:	117 cm / 46"
Engine:	EFI Cub Cadet, V-Twin dual cylinder, 679 cm ³
Rated power:	16.5 kW / 2,600 min ⁻¹
Drive:	Hydrostatic

Model no.: 13BZA1CN603

"The Bluetooth® word mark and logos are registered trademarks owned by the Bluetooth SIG, Inc. and any use of such marks by MTD is under license. Other trademarks and trade names are those of their respective owners."



XT3™

ENDURO SERIES™

MAXIMUM STRENGTH AND POWER FOR THE TOUGHEST TASKS

Designed for the toughest, most demanding conditions, driven by true power packages and equipped with ultra-strong components – the Cub Cadet XT3 are the ultimate lawn tractors. The XT3 range is built to tackle the hardest tasks, where maximum strength and power is required. The XT3's are brimming with power, capable of mowing tall, dense grass and transporting larger loads. The rear discharge models come equipped with an impressive 360L grass bag and feature an Anti-Dust System and a multi-layered dust apron to protect against swirling grass and dirt.



LARGE COLLECTION BOX
Vast 360 litre capacity ensures maximum efficiency



STRONG V-TWIN KAWASAKI ENGINE
For superior power and higher-torque



ANTI-DUST SYSTEM
XT3 rear discharge models come with a zip on Anti-Dust System, protecting you from swirling grass and dust



EXTREMELY STABLE V-BELT SYSTEM
The most powerful drive force, even with extreme demands

Powered by

Kawasaki

POWERFUL KAWASAKI V-TWIN ENGINE

Superior power and higher torque – perfect for all terrain requirements



CUB CONNECT BLUETOOTH® APP

Get updates about status & inspection dates via smart-phone – and charge your phone with multifunction socket

Cub Cadet ALL-GROUND TRACTION

Mechanical differential lock provides the optimum traction on all terrains.



Powered by
Kawasaki

3-in-1
OPTION



XT3 QS127

Cutting width:	127 cm / 50 "
Engine:	Kawasaki, V-Twin, 726 cm ³
Rated power:	16.9 kW / 2,900 min ⁻¹
Drive:	Hydrostatic

Model no.: 14AIA5CQ603



Powered by
Kawasaki

3-in-1
OPTION



XT3 QS137

FABRICATED DECK

Cutting width:	137 cm / 54 "
Engine:	Kawasaki, V-Twin, 726 cm ³
Rated power:	16.9 kW / 3,000 min ⁻¹
Drive:	Hydrostatic

Model no.: 14AIA5CA603



Powered by
Kawasaki

3-in-1
OPTION



XT3 QR95

Cutting width:	95 cm / 38 "
Engine:	Kawasaki, V-Twin, 726 cm ³
Rated power:	15.8 kW / 2,500 min ⁻¹
Drive:	Hydrostatic

Model no.: 13BFA5CB603

SPECIAL ORDER



ELECTRIC BAG CATCHER



Powered by
Kawasaki

3-in-1
OPTION



XT3 QR106e

NEW

Cutting width:	106 cm / 42 "
Engine:	Kawasaki, V-Twin, 726 cm ³ , electric bag lift
Rated power:	16.9 kW / 2,300 min ⁻¹
Drive:	Hydrostatic



Model no.: 13BIA5CR603

"The Bluetooth® word mark and logos are registered trademarks owned by the Bluetooth SIG, Inc. and any use of such marks by MTD is under license. Other trademarks and trade names are those of their respective owners."

	XT1 OR95	XT1 OR106	XT1 OS96	
ENGINE	Engine type	Cub Cadet 547	Cub Cadet 547	Cub Cadet 547
	Engine displacement	547 cm ³	547 cm ³	547 cm ³
	Rated power	12.9 kW / 2,400 min ⁻¹	12.9 kW / 2,450 min ⁻¹	12.9 kW / 2,400 min ⁻¹
	Cylinders	Single	Single	Single
	Tank volume (capacity)	11.4 l	11.4 l	11.4 l
Lubrication	Fully pressurised with automotive - style oil pump spin-on oil filter	Fully pressurised with automotive - style oil pump spin-on oil filter	Fully pressurised with automotive - style oil pump spin-on oil filter	
DRIVE SYSTEM	Transmission	Hydrostatic	Hydrostatic	Hydrostatic
	Speeds	Infinitely variable	Infinitely variable	Infinitely variable
	Control	Foot pedal control	Foot pedal control	Foot pedal control
	Cruise control	Soft touch engagement	Soft touch engagement	Soft touch engagement
CUTTING SYSTEM	Mowing area in m ² /h	5,500	7,500	6,000
	Cutting width	95 cm / 38 "	106 cm / 42 "	96 cm / 38 "
	Cutting height (min-max)	25–100 mm	25–100 mm	25–100 mm
	Cutting options	3-in-1 Option	3-in-1 Option	3-in-1 Option
	Number of blades	2	2	2
	Deck engagement	Electric PTO	Electric PTO	Electric PTO
	Deck height positions	12	12	12
	Deck wheels	2 Ball / 2 Narrow	2 Ball / 2 Narrow	2 Ball / 2 Narrow
	Wash nozzle / mulching plug	Standard / (196-551-000) Kit (196-561-000) Blades	Standard / (196-550-000) Kit (196-560-000) Blades	–/Standard
	Bag (capacity) / accessory no	320 /-	320 /-	- / (OEMR190-180A)
DISCHARGE SYSTEM	Bag lever / hardtop	Telescopic / Plastic	Telescopic / Plastic	-/-
	Bag full indicator / grass deflector	Deluxe w Blade Shutoff / (196-552-000)	Deluxe w Blade Shutoff / (196-552-000)	– / Standard
	Front axle	Heavy-Duty cast-iron	Heavy-Duty cast-iron	Heavy-Duty cast-iron
FRAME	Front bumper	-	-	-
	Turning radius	TIGHT TURN 38 cm / 15"	TIGHT TURN 38 cm / 15"	TIGHT TURN 38 cm / 15"
	Wheel size (front/rear)	15" x 6" Turf Saver / 18" x 8.5"	15" x 6" Turf Saver / 18" x 8.5"	15" x 6" Turf Saver / 20" x 8"
	Wheel bearings	Sleeve bearings	Sleeve bearings	Sleeve bearings
	Easy entry frame	Fully robotically-welded frame with e-coating corrosion defense system	Fully robotically-welded frame with e-coating corrosion defense system	Fully robotically-welded frame with e-coating corrosion defense system
ELECTRICAL SYSTEM	Battery	12 V Heavy-Duty	12 V Heavy-Duty	12 V Heavy-Duty
	Headlights	LED High Illumination	LED High Illumination	LED High Illumination
	System monitor package	-	-	-
	Safety systems	Neutral start, operator presence, brake pedal lock	Neutral start, operator presence, brake pedal lock	Neutral start, operator presence, brake pedal lock
COMFORT	Seat type	High Back Seat Cub Cadet I	High Back Seat Cub Cadet I	High Back Seat Cub Cadet I
	Seat adjustment	Lever, angled, 10 slide	Lever, angled, 10 slide	Lever, angled, 10 slide
	Steering wheel	Ergo Softgrip Black	Ergo Softgrip Black	Ergo Softgrip Black
	Tool box / 12 V plug	Toolbox & Cupholder	Toolbox & Cupholder	Toolbox & Cupholder
	Mow in reverse (RevTEK™)	Standard	Standard	Standard
Battery charger	(196-967-678)	(196-967-678)	(196-967-678)	
DIMENSIONS	LpA / LwA / LwAg (dB)	88 / 98 / 100	88 / 98 / 100	88 / 98 / 100
	Vibration value body / (K-factor)	1 / 0.5 m/s ²	1 / 0.5 m/s ²	1 / 0.5 m/s ²
	Dimensions (L/W/H)	245 cm / 100 cm / 118 cm	245 cm / 110 cm / 118 cm	175 cm / 106 cm / 110 cm
	Weight net	235 kg	258 kg	195 kg
Model number	13B8A1CB603	13B8A1CR603	13A8A1CF603	
EAN	 4 008423 872217	 4 008423 872231	 4 008423 872224	

XT1 OS107	XT2 PR95	XT2 QR106	XT2 PR106ie
Cub Cadet 547	Kawasaki	Kawasaki	Cub Cadet EFI,
547 cm ³	603 cm ³	726 cm ³	679 cm ³
12.9 kW / 2,400 min ⁻¹	13.2 kW / 2,500 min ⁻¹	15.8 kW / 2,500 min ⁻¹	16.5 kW / 2,150 min ⁻¹
Single	V-Twin	V-Twin	V-Twin
11.4 l	11.4 l	11.4 l	9.5 l
Fully pressurised with automotive - style oil pump spin-on oil filter	Fully pressurised with automotive - style oil pump spin-on oil filter	Fully pressurised with automotive - style oil pump spin-on oil filter	Fully pressurised with automotive - style oil pump spin-on oil filter
Hydrostatic	Hydrostatic	Hydrostatic	Hydrostatic
Infinitely variable	Infinitely variable	Infinitely variable	Infinitely variable
Foot pedal control	Foot pedal control	Foot pedal control	Foot pedal control
Soft touch engagement	Soft touch engagement	Soft touch engagement	Soft touch engagement
8,000	6,000	8,000	8,000
107 cm / 42 "	95 cm / 38 "	106 cm / 42 "	106 cm / 42 "
25–100 mm	25–100 mm	25–100 mm	25–100 mm
3-in-1 Option	3-in-1 Option	3-in-1 Option	3-in-1 Option
2	2	2	2
Electric PTO	Electric PTO	Electric PTO	Electric PTO
12	12	12	12
2 Ball / 2 Narrow	2 Ball / 2 Narrow	2 Ball / 2 Narrow	2 Ball / 2 Narrow
Standard/Standard	Standard / (196-551-000) Kit (196-561-000) Blades	Standard / (196-550-000) Kit (196-560-000) Blades	Standard / (196-550-000) Kit (196-560-000) Blades
- / (19A30003100)	320 / -	320 / -	320 / -
- / -	Telescopic / Plastic	Telescopic / Plastic	Electric / Plastic
- / Standard	Deluxe w Blade Shutoff / (196-552-000)	Deluxe w Blade Shutoff / (196-552-000)	Deluxe w Blade Shutoff / (196-552-000)
Heavy-Duty cast-iron	Heavy-Duty cast-iron	Heavy-Duty cast-iron	Heavy-Duty cast-iron
-	Single Tube	Single Tube	Single Tube
TIGHT TURN 38 cm / 15"	TIGHT TURN xTREME 17 cm / 6.6"	TIGHT TURN xTREME 17 cm / 6.6"	TIGHT TURN xTREME 17 cm / 6.6"
15" x 6" Turf Saver / 20" x 8"	15" x 6" Turf Saver / 18" x 8.5"	15" x 6" Turf Saver / 18" x 8.5"	15" x 6" Turf Saver / 18" x 8.5"
Sleeve bearings	Sleeve bearings	Sleeve bearings	Sleeve bearings
Fully robotically-welded frame with e-coating corrosion defense system	Fully robotically-welded frame with e-coating corrosion defense system	Fully robotically-welded frame with e-coating corrosion defense system	Fully robotically-welded frame with e-coating corrosion defense system
12 V Heavy-Duty	12 V Heavy-Duty	12 V Heavy-Duty	12 V Heavy-Duty
LED High Illumination	LED High Illumination	LED High Illumination	LED High Illumination
-	Cub Connect APP	Cub Connect APP	Cub Connect APP
Neutral start, operator presence, brake pedal lock	Neutral start, operator presence, brake pedal lock	Neutral start, operator presence, brake pedal lock	Neutral start, operator presence, brake pedal lock
High Back Seat Cub Cadet I	High Back Seat Cub Cadet II	High Back Seat Cub Cadet II	High Back Seat Cub Cadet II
Lever, angled, 10 slide	Lever, angled, 10 slide	Lever, angled, 10 slide	Lever, angled, 10 slide
Ergo Softgrip Black	Ergo Softgrip Black	Ergo Softgrip Black	Ergo Softgrip Black
Toolbox & Cupholder	Toolbox & Cupholder / 12 V Socket	Toolbox & Cupholder / 12 V Socket	Toolbox & Cupholder / 12 V Socket
Standard	Standard	Standard	Standard
(196-967-678)	(196-967-678)	(196-967-678)	(196-967-678)
88 / 98 / 100	88 / 98 / 100	88 / 98 / 100	88 / 98 / 100
1 / 0.5 m/s ²	1 / 0.5 m/s ²	1 / 0.5 m/s ²	1 / 0.5 m/s ²
175 cm / 134 cm / 110 cm	250 cm / 100 cm / 118 cm	250 cm / 110 cm / 118 cm	250 cm / 110 cm / 118 cm
195 kg	254 kg	253 kg	253 kg
13A8A1CS603	13BGA1CB603	13BFA1CR603	13BZA1CR603
			
4 008423 872248	4 008423 872279	4 008423 872262	4 008423 881899 >

LAWN TRACTOR SPECIFICATIONS

	XT2 PS107	XT2 PS117	XT2 PS117i	
ENGINE	Engine type	Kawasaki	Kawasaki	Cub Cadet EFI,
	Engine displacement	603 cm ³	603 cm ³	679 cm ³
	Rated power	13.4 kW / 2,250 min ⁻¹	13.4 kW / 2,600 min ⁻¹	16.5 kW / 2,600 min ⁻¹
	Cylinders	V-Twin	V-Twin	V-Twin
	Tank volume (capacity)	11.4 l	11.4 l	9.5 l
DRIVE SYSTEM	Lubrication	Fully pressurised with automotive - style oil pump spin-on oil filter	Fully pressurised with automotive - style oil pump spin-on oil filter	Fully pressurised with automotive - style oil pump spin-on oil filter
	Transmission	Hydrostatic	Hydrostatic	Hydrostatic
	Speeds	Infinitely variable	Infinitely variable	Infinitely variable
	Control	Foot pedal control	Foot pedal control	Foot pedal control
CUTTING SYSTEM	Cruise control	Soft touch engagement	Soft touch engagement	Soft touch engagement
	Mowing area in m ² /h	8,500	9,000	9,000
	Cutting width	107 cm / 42 "	117 cm / 46 "	117 cm / 46 " Fabricated Deck
	Cutting height (min-max)	25–100 mm	25–100 mm	25–100 mm
	Cutting options	3-in-1 Option	3-in-1 Option	3-in-1 Option
	Number of blades	2	2	2
	Deck engagement	Electric PTO	Electric PTO	Electric PTO
	Deck height positions	12	12	12
	Deck wheels	2 Ball / 2 Ball	2 Ball / 2 Ball	2 Ball / 2 Ball
	Wash nozzle / mulching plug	Standard / Standard	Standard / Standard	Standard / Standard
DISCHARGE SYSTEM	Bag (capacity) / accessory no	- / (19A30003100)	- / (19A30003100)	-/-
	Bag lever / hardtop	-/-	-/-	- / (19A30003100)
	Bag full indicator / grass deflector	- / Standard	- / Standard	- / Standard
FRAME	Front axle	Heavy-Duty cast-iron	Heavy-Duty cast-iron	Heavy-Duty cast-iron
	Front bumper	Single Tube	Single Tube	Single Tube
	Turning radius	TIGHT TURN xTREME 17 cm / 6.6"	TIGHT TURN xTREME 17 cm / 6.6"	TIGHT TURN xTREME 17 cm / 6.6"
	Wheel size (front/rear)	15" x 6" / 20" x 8"	15" x 6" Turf Saver / 20" x 8"	15" x 6" Turf Saver / 18" x 8.5"
	Wheel bearings	Sleeve bearings	Sleeve bearings	Sleeve bearings
	Easy entry frame	Fully robotically-welded frame with e-coating corrosion defence system	Fully robotically-welded frame with e-coating corrosion defence system	Fully robotically-welded frame with e-coating corrosion defence system
ELECTRICAL SYSTEM	Battery	12 V Heavy-Duty	12 V Heavy-Duty	12 V Heavy-Duty
	Headlights	LED High Illumination	LED High Illumination	LED High Illumination
	System monitor package	Cub Connect APP	Cub Connect APP	Cub Connect APP
	Safety systems	Neutral start, operator presence, brake pedal lock	Neutral start, operator presence, brake pedal lock	Neutral start, operator presence, brake pedal lock
COMFORT	Seat type	High Back Seat Cub Cadet II	High Back Seat Cub Cadet II	High Back Seat Cub Cadet II
	Seat adjustment	Lever, angled, 10 slide	Lever, angled, 10 slide	Lever, angled, 10 slide
	Steering wheel	Ergo Softgrip Black	Ergo Softgrip Black	Ergo Softgrip Black
	Tool box/12 V plug	Toolbox & Cupholder / 12 V Socket	Toolbox & Cupholder / 12 V Socket	Toolbox & Cupholder / 12 V Socket
	Mow in reverse (RevTEK™)	Standard	Standard	Standard
	Battery charger	(196-967-678)	(196-967-678)	(196-967-678)
	DIMENSIONS	LpA / LwA / LwAg (dB)	88 / 98 / 100	88 / 98 / 100
Vibration value body/ (K-factor)		1 / 0.5 m/s ²	1 / 0.5 m/s ²	1 / 0.5 m/s ²
Dimensions (L/W/H)		180 cm / 116 cm / 110 cm	180 cm / 126 cm / 110 cm	180 cm / 122 cm / 110 cm
Weight net		210 kg	215 kg	230 kg
Model number	13AGA1CS603	13AGA1CT603	13BZA1CN603	
EAN	 4 008423 872286	 4 008423 872293	 4 008423 881943	

XT3 QR95	XT3 QR106e	XT3 QS127	XT3 QS137
Kawasaki	Kawasaki	Kawasaki	Kawasaki
726 cm ³	726 cm ³	726 cm ³	726 cm ³
15.8 kW / 2,500 min ⁻¹	16.9 kW / 2,300 min ⁻¹	16.9 kW / 2,900 min ⁻¹	16.9 kW / 3,000 min ⁻¹
V-Twin	V-Twin	V-Twin	V-Twin
11.4 l	11.4 l	11.4 l	11.4 l
Fully pressurised with automotive - style oil pump spin-on oil filter	Fully pressurised with automotive - style oil pump spin-on oil filter	Fully pressurised with automotive - style oil pump spin-on oil filter	Fully pressurised with automotive - style oil pump spin-on oil filter
Hydrostatic	Hydrostatic	Hydrostatic	Hydrostatic
Infinitely variable	Infinitely variable	Infinitely variable	Infinitely variable
Foot pedal control	Foot pedal control	Foot pedal control	Foot pedal control
Soft touch engagement	Soft touch engagement	Soft touch engagement	Soft touch engagement
6,000	8,000	10,000	11,000
95 cm / 38 "	106 cm / 42 "	127 cm / 50 "	137 cm / 54 " Fabricated Deck
25-100 mm	25-100 mm	25-100 mm	25-100 mm
3-in-1 Option	3-in-1 Option	3-in-1 Option	3-in-1 Option
2	2	3	3
Electric PTO	Electric PTO	Electric PTO	Electric PTO
12	12	12	12
2 Ball / 2 Narrow	2 Ball / 2 Narrow	1 Nose Rlr / 2 Ball / 2 Ball	1 Nose Rlr / 2 Ball / 2 Ball
Standard / (196-551-000) Kit (196-561-000) Blades	Standard / (196-550-000) Kit (196-560-000) Blades	Standard / Standard	Standard / Standard
360 l /-	360 l /-	- / (19A30018100)	- / (19A30018100)
Telescopic / Plastic	Electric / Plastic	-/-	-/-
Deluxe w Blade Shutoff / (196-552-000)	Deluxe w Blade Shutoff / (196-552-000)	- / Standard	- / Standard
Heavy-Duty cast-iron	Heavy-Duty cast-iron	Heavy-Duty cast-iron	Heavy-Duty cast-iron
Deluxe	Deluxe	Deluxe	Deluxe
TIGHT TURN 38 cm / 15"	TIGHT TURN 38 cm / 15"	TIGHT TURN 38 cm / 15"	TIGHT TURN 38 cm / 15"
15" x 6" Multi Trac / 18" x 8.5"	15" x 6" Multi Trac / 18" x 8.5"	16" x 6.5-8" Turf Master / 22" x 9.5"	16" x 6.5-8" Turf Master / 22" x 9.5"
Sleeve bearings	Sleeve bearings	Ball bearings	Ball bearings
Fully robotically-welded frame with e-coating corrosion defence system	Fully robotically-welded frame with e-coating corrosion defence system	Fully robotically-welded frame with e-coating corrosion defence system	Fully robotically-welded frame with e-coating corrosion defence system
12 V Heavy-Duty	12 V Heavy-Duty	12 V Heavy-Duty	12 V Heavy-Duty
LED High Illumination	LED High Illumination	LED High Illumination	LED High Illumination
Cub Connect APP	Cub Connect APP	Cub Connect APP	Cub Connect APP
Neutral start, operator presence, brake pedal lock	Neutral start, operator presence, brake pedal lock	Neutral start, operator presence, brake pedal lock	Neutral start, operator presence, brake pedal lock
High Back Seat Cub Cadet II / Armrests	High Back Seat Cub Cadet II / Armrests	High Back Seat Cub Cadet II / Armrests	High Back Seat Cub Cadet II / Armrests
Lever, angled, 10 slide	Lever, angled, 10 slide	Lever, angled, 10 slide	Lever, angled, 10 slide
Ergo Softgrip Black	Ergo Softgrip Black	Ergo Softgrip Black	Ergo Softgrip Black
Toolbox & Cupholder / 12 V Socket	Toolbox & Cupholder / 12 V Socket	Toolbox & Cupholder / 12 V Socket	Toolbox & Cupholder / 12 V Socket
Standard	Standard	Standard	Standard
(196-967-678)	(196-967-678)	(196-967-678)	(196-967-678)
88 / 98 / 100	88 / 98 / 100	110 / 93 / 103	110 / 93 / 103
1 / 0.5 m/s ²	1 / 0.5 m/s ²	1 / 0.5 m/s ²	1 / 0.5 m/s ²
267 cm / 100 cm / 118 cm	267 cm / 110 cm / 118 cm	197 cm / 136 cm / 110 cm	197 cm / 145 cm / 110 cm
247 kg	268 kg	260 kg	270 kg
13BFA5CB603	13BIA5CR603	14AIA5CQ603	14AIA5CA603
 4 008423 872828	 4 008423 872316	 4 008423 872545	 4 008423 872323

4

LAWN TRACTOR SPECIFICATIONS

Cub Cadet

**PERFORMANCE,
RIGHT FROM THE
START.**



LH3
FORCE SERIES

[71] 80V LI-ION DURA SYSTEM



80V LITHIUM-ION BATTERY GARDEN TOOLS

Innovation, power and performance are all strengths of Cub Cadet garden machinery. Never more so than shown through our new lithium-ion battery technology range – the 80V Li-ION DURA SYSTEM. Right from the start, the DURA garden tools range has been designed to excel in terms of performance, capacity and flexibility. They are ideal for everyone who needs high performance from green technology across various garden tools.

NEW

GARDEN TOOLS WITH INTERCHARGEABLE BATTERY TECHNOLOGY.

80V 
LI-ION DURA SYSTEM



PERFORMANCE, RIGHT FROM THE START.

The new 80V Li-ION DURA SYSTEM packs a real punch! The lithium-ion battery is interchangeable across the entire range and the high charging 80V capacity makes it especially powerful and long lasting in these gardening tools.

THE NEW CUB CADET 80V TECHNOLOGY

Cub Cadet Li-ION DURA SYSTEM garden tools have been specially designed and developed to maximise performance and range. They are extremely quiet and eco-friendly, require minimal care and maintenance and with no emissions or cables to get tangled, they provide the performance and freedom to get the job done.

MAIN ADVANTAGES OF THE 80V LI-ION DURA SYSTEM:

- One battery for all 80V Li-ION Dura System tools: lawn trimmer, hedge trimmer, leaf blower and lawnmowers
- 80V Li-ION rapid-charge station charges the battery in just one hour, one of the fastest charge cycles on the market
- Simply slot in, engage securely – and you're ready to go!



ONE BATTERY FOR ALL TOOLS.

THE 80V LI-ION DURA SYSTEM RANGE.

Five powerful gardening tools for trimming lawn edges, cutting hedges, removing leaves and mowing lawns. Naturally, they are all available with the 80V Li-ION power pack as well as the rapid charger – either as optional extras or included in a complete set.

LAWN TRIMMER LH3 ET



HEDGE TRIMMER LH3 EH



LAWNMOWERS LM3 E37 AND E40



LEAF BLOWER LH3 EB



READY FOR USE IN SECONDS
Simply slot in, engage securely and you're ready to go!

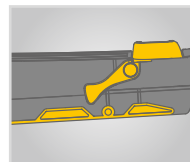

CLICK MECHANISM TO QUICKLY LOCK AND UNLOCK THE BATTERY
Simply plug it in, securely snap into place – done! Unlocking is just as easy: safely disengage the battery with no risk of dropping it and simply remove.



INTEGRATED COOLING AND VENTILATION SYSTEM
Ensures safe charging and prevents battery from overheating, extending the battery service life.



READY TO USE AFTER JUST 1 HOUR
The 80V rapid charging station charges batteries in just one hour – one of the fastest charging cycles on the market!

1

2

3

4

5

80V LI-ION DURA SYSTEM GARDEN TOOLS

6

7

8

9



180°

—Cub Cadet®— SWIVEL-ACTION BLADE

The blades are adjustable in five positions: 90°/45°/0°/-45°/-90°. Keeping your hands in the ideal position at all times and avoiding entanglement in the branches.

LH3 EH HEDGE TRIMMER

KEEP HEDGES IN SHAPE EFFORTLESSLY

The Cub Cadet 80V hedge trimmer adjusts flexibly to your hedge so you don't have to stretch.



COMFORT HANDLE
with Soft-Grip for safe and comfortable handling

EXTRA LONG BATTERY RANGE
with up to 90 minutes' cutting performance

LIGHTWEIGHT HOUSING
For easy, fatigue-free working

SWIVEL-ACTION BLADE
turns by 180° in five positions – letting you choose the perfect position for your hands

LH3 EH

SIMILAR TO PHOTO

Runtime:	up to 90 min
Charging time:	60 min
Cutting height:	55 cm
Blade spacing:	26 mm
Swivel-action blade:	Standard
Extra long battery range:	Standard
Comfort Handle:	Standard

ALSO AVAILABLE AS SET
Incl. battery & rapid charger

LH3 EH Set



Model no.: 41AG0DN-603

NEW

Model no.: 41AG0DO-603

Run time can be affected by usage and should be used as a guide only.

ACCESSORIES

80V LI-ION DURA SYSTEM ACCESSORIES

80V POWER-PACK battery, 5 Ah		Mod. no.: 196A650-603
POWER CHARGER 80V LI-ION, 6 Ah		Mod. no.: 196A651-603
Blades for 80V trimmer		Mod. no.: 196-631-603
Leaf scraper for 80V blower		Mod. no.: 196-630-603



—Cub Cadet— MULCH COVER

Thanks to the lockable mulch cover, the cuttings remain in a narrow 50 cm area instead of spreading across a 2-metre radius.

LH3 ET LINE TRIMMER

TRIM AND CUT BACK GRASS WITH EXTRA POWER

The ideal trimmer when you want to remove grass at lawn edges and even cut back long brush on inclines.

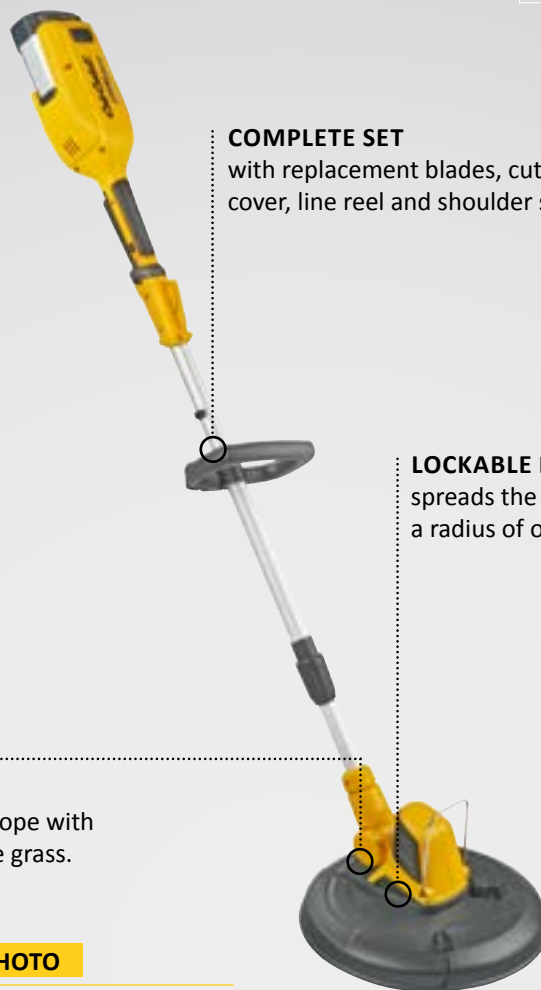

COMPLETE SET
with replacement blades, cutting head cover, line reel and shoulder strap

LOCKABLE MULCH COVER
spreads the cuttings over a radius of only 50 cm instead of 2 m

TOOL-FREE ADD-ONS
Add a plastic blade to cope with thicker and more dense grass.

LH3 ET

SIMILAR TO PHOTO

Runtime:	up to 60 min
Charging time:	60 min
Line thickness:	1.6 mm
Cutting width:	30 cm
Lockable mulch cover:	Standard
Tool-free add-ons:	Standard
Complete set:	Standard

Model no.: 41AE0UO-603

ALSO AVAILABLE AS SET
Incl. battery & rapid charger

LH3 ET Set



Model no.: 41AE0UN-603

NEW

Run time can be affected by usage and should be used as a guide only.



—Cub Cadet®— AXIAL FAN

The axial fan offers enhanced efficiency in every stage as well as maximum air circulation through a vertical design.

LH3 EB LEAF BLOWER

QUICKLY CLEAR DRY OR WET LEAVES

With the Cub Cadet 80V leaf blower, clearing the autumn carpet of leaves is a blast! This tool is powerful enough to shift wet as well as dry leaves.



LH3 EB

SIMILAR TO PHOTO

Runtime:	Full throttle 30 min, full throttle + turbo 10 min
Charging time:	60 min
Speed:	240 km/h
Air flow:	750 m ³ /h
Axial fan:	Standard
Selector switch:	Standard
Narrow and wide nozzle:	Standard

ALSO AVAILABLE AS SET
Incl. battery & rapid charger

LH3 EB Set



Model no.: 41AA0BN-603

NEW

Model no.: 41AA0BO-603

Run time can be affected by usage and should be used as a guide only.

LIGHTWEIGHT MOWING AND MULCHING LAWNMOWERS

Do you want the performance of a combustion engine but without the noise and engine fumes? Then the two 80V lawnmowers are perfect! Packed with market leading developments, from the leading lithium battery, 3-in-1 cutting options to the boosted airflow technology, these lawnmowers are lightweight and pack a punch when it comes to performance.



POWER DRIVE

Long-range mowing with the powerful, maintenance-free and brushless 80V motor.



BOOSTED AIRFLOW TECHNOLOGY

For optimal transport of the cuttings to the grass catcher.



3-IN-1 SYSTEM

Rear discharge, collection and mulching in a single tool – adjustable settings.



COMPLETE SET

Including a battery and rapid charger.



LM3 E37

NEW

Cutting width:	37 cm / 14.5"
Recommended area capacity:	300–500 m ²
Bag capacity:	40 l
Cutting height adjustment:	6 positions from 25–75 mm
3-in-1 System:	Standard
Boosted-Airflow technology:	Standard
Net weight:	21 kg

Model no.: 18AKHJ23603









LM3 E40



NEW

Cutting width:	40 cm / 16"
Recommended area capacity:	500–800 m ²
Bag capacity:	45 l
Cutting height adjustment:	6 positions from 25–75 mm
3-in-1 System:	Standard
Boosted-Airflow technology:	Standard
Net weight:	23 kg

Model no.: Model no.: 18AKJJ33603

	LH3 EB	LH3 EH	LH3 ET
BATTERY			
Battery/Charger	(196A650-603)/(196A651-603)	(196A650-603)/(196A651-603)	(196A650-603)/(196A651-603)
Runtime	Full throttle 30 min, full throttle + turbo 10 min	up to 90 min	up to 60 min
Charging time/charging cycles	60 min	60 min	60 min
Voltage	80V max.	80V max.	80V max.
Speed (max.)	240 km/h	-	-
Air flow	750 m ³ /h	-	-
Housing (material)	poly-plastic	poly-plastic	poly-plastic
FEATURES			
Cutting length	-	55 cm	-
Blade spacing	-	26 mm	-
Cutting width	-	-	30 cm
Line thickness	-	-	1,6 mm
Line spool	-	-	Double line
Axial fan	Standard	-	-
Turbo mode	Standard	-	-
Narrow nozzle & wide nozzle	Standard	-	-
MAIN FEATURES			
Swivel action blade	-	Standard	-
Comfort handle	-	Standard	-
Lightweight housing	-	Standard	-
Tool-free add-on	-	-	Standard
Lockable mulch cover	-	-	Standard
Complete set	-	-	Standard
DIMENSIONS			
LpA/LwA/LwAg (dB)	86.3 / 98.7 / 101	84 / 96 / 99	86 / 94 / 96
Vibration value hand/arm / K-factor	2.8 / 1.5 m/s ²	2.5 / 1.5 m/s ²	2.5 / 1.5 m/s ²
Dimensions (L/W/H)	-	-	-
Net weight	2.9 kg	3.5 kg	3.0 kg
Model number	41AA0BO-603	41AG0DO-603	41AE0UO-603
EAN	 4 008423 883008	 4 008423 882223	 4 008423 882209

	LH3 EB Set	LH3 EH Set	LH3 ET Set
Battery/Charger	included	included	included
Model number	41AA0BN-603	41AG0DN-603	41AE0UN-603
EAN	 4 008423 882179	 4 008423 882216	 4 008423 882193

	LM3 E37	LM3 E40	
BATTERY	Battery/Charger	included	included
	Runtime	–	–
	Charging time/charging cycles	60 min	60 min
	Voltage	80V max.	80V max.
DRIVE SYSTEM	Drive	Pushed	Pushed
	Driving stages	–	–
CUTTING SYSTEM	Lawn area	300–500 m ²	500–800 m ²
	Housing (material)	poly-plastic	poly-plastic
	Cutting width	37 cm	40 cm
	Mowing options	3-in-1	3-in-1
	Cutting height adjustment	6 Positions/central	6 Positions/central
	Cutting height (min/max)	25–75 mm	25–75 mm
	Grass collection	Standard	Standard
	Mulching kit	Standard	Standard
	Side discharge	–	–
	Rear discharge without grass catcher	Standard	Standard
DISCHARGE SYSTEM	Grass catcher	Fabric grass catcher with cover	Fabric grass catcher with cover
	Grass catcher (capacity)	40 l	45 l
	Filling level indicator	Standard	Standard
WHEELS	Wheels (f/r)	150 mm/200 mm	150 mm/200 mm
	Double ball bearing	Standard	Standard
	Folding bar	Standard	Standard
	Height-adjustable bar	Standard	Standard
	Covering on bar	Soft-Grip	Soft-Grip
DIMENSIONS	LpA/LwA/LwAg (dB)	79.7 / 94 / 96	77.8 / 94 / 96
	Vibration value hand/arm / K-factor	2.5 / 1.5 m/s ²	2.5 / 1.5 m/s ²
	Dimensions (L/W/H)	139 cm / 40 cm / 110 cm	139 cm / 43 cm / 110 cm
	Net weight	21 kg	23 kg
Model number	18AKHJ23603	18AKJJ33603	
EAN	 4 008423 882 131	 4 008423 882 148	

ENDURO SERIES™

**THE RIGHT POWER
FOR YOUR TERRAIN.**





CHORE PERFORMERS.

Innovation, selection and performance are all strengths of the complete line up of Cub Cadet chore performers. From the ground breaking XC3 F46 tiller and the LC3 DP56 lawn trimmer, up to the XC1 B40 scarifier, Cub Cadet chore performers support you with a strong engine and a powerful performance during the whole gardening season.



STRONG ENOUGH TO CUT EVERYTHING.

The Cub Cadet LC3 DP56 mobile lawn trimmer is so strong it meets any challenge – however tough the conditions. With the powerful Cub Cadet engine and ultra-large 56 cm cutting width, trim long grass and weeds at a stroke.



LC3 DP56

Cutting width:	56 cm
Cutting height:	60–110 mm
Line:	4 mm ø
Engine:	Cub Cadet 55cc OHV
Wheels:	36 cm ø
Drive:	Pushed
Weight:	31 kg

Model no.: 25A-262E603

REPLACEMENT LINE FOR LC3 DP56

10 pcs. of cutting line, cut to 3.9 mm x 47 cm length



4 056494 116662

Mod. No.: 1182-WS-0001



EASY HEIGHT ADJUSTMENT

Adjust the cutting height to your requirements with ease: set low to trim along fences, walls and buildings, higher for long, dense weeds on open ground.



POWERFUL PERFORMANCE

Thanks to the power of a high-quality Cub Cadet engine with AutoChoke, managing tough jobs is a breeze.



EXCEPTIONALLY EASY TO HANDLE

The large 36 cm diameter wheels negotiate uneven ground with remarkable agility. The special design of the cutting head helps you effortlessly curve around obstacles and reach into corners.



GROUND BREAKING, IN EVERY SENSE OF THE WORD.

Using the XC3 garden tiller, the strenuous and time consuming work of digging and loosening the soil by hand with a spade, is a thing of the past. Powerful and reliable, this tiller facilitates seed preparation in even hard and clumpy soils and is ideal for areas up to 1,000m². Four, self-sharpening, heat-treated, high quality tine sets made of steel ensure excellent working results at a tilling width of 46 cm / 18".



XC3 F46

Cutting width:	46 cm / 18"
Engine:	Cub Cadet 65 H, 208 cm ³
Rated power:	3.9 kW / 3,600 min ⁻¹
Drive:	Dual Direction

Model no.: 21BB45M8603

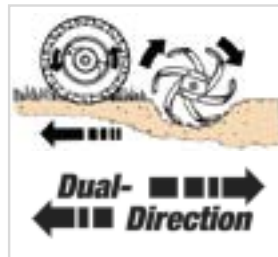

DUAL TINE DIRECTION

With 33 cm / 13" dual direction, self-sharpening tines, the XC3 tiller provides fine cultivating and seedbed preparation in any soil.



EASY TO USE

Single-hand operation lets you stand to the side and steer the tiller with one hand. Comfortable full bail handle with soft grips.



DEPTH STAKE

The adjustable depth bar gives the tiller better stability and allows the tilling depth to be controlled.

4

5

6

CHORE PERFORMERS

7

8

9



Picture shows optional grass collector

BEAUTY TREATMENT FOR YOUR LAWN.

Scarifying is an important part of the perfect lawn care. It helps to fight against the notorious thatch which is formed in every lawn and blocks the supply of air, water and nutrients to the roots. Correct scarifying will let the lawn breathe again. The Cub Cadet XC1 scarifiers will bring the right power to remove thatch so that sunlight, air and water can reach the soil and roots. This means you get two functions from one machine: aerating and scarifying.



XC1 B40

ALSO AVAILABLE IN
35CM WIDTH MODEL XC1 B35

Cutting width: 40 cm / 16 "

Engine: Cub Cadet 35H OHV
123 cm³

Rated power: 2.3 kW / 3,600 min⁻¹

Drive: Push

Model no.: 16CH8AMQ603



BLADES AND SPRINGS

The XC1 B35 has 15 flail blades and 14 springs and the XC1 B40 has 17 flail blades and 16 springs. This combination allows for two functions in one machine: aerating and scarifying.

If you would like to aerate the soil use the higher position with a gentle touch of the blades and springs on the surface of the soil. If there is the need to scarify, use a deeper position of the blades and springs which allows a more aggressive action on the surface.







REMOTE TRANSPORT POSITION

With the lever on the handle you can switch from transport to working quickly and easily.



WORKING DEPTH ADJUSTMENT

The working depth can easily be changed centrally.

	XC1 B35	XC1 B40	LC3 DP56	XC3 F46	
ENGINE	Engine type	Cub Cadet 35 H OHV	Cub Cadet 35 H OHV	Cub Cadet 55 OHV	Cub Cadet 65 H
	Engine displacement	123 cm ³	123 cm ³	159 cm ³	208 cm ³
	Rated power (kW / min ⁻¹)	2.3 / 3,600	2.3 / 3,600	2.1 / 2,800	3.9 / 3,600
	Engine start	Pull	Pull	Pull	Pull
	Tank volume (capacity) (l)	1.7	1.7	1.0 l	2.2 l
DRIVE SYSTEM	Drive	Push	Push	Push	Dual direction
	Number of speeds	–	–	–	–
	Speed (max)	–	–	–	–
WORKING METHOD	Chassis (material)	Steel chassis with plastic cover	Steel chassis with plastic cover	–	–
	Working width (cm / inches)	35 cm / 14"	40 cm / 16"	56 cm / 22"	46 / 18"
	Tine re-adjustment	Infinite / central	Infinite / central	–	–
	Adjustment range (mm)	0 to -15	0 to -15	–	–
	Transport position	Standard	Standard	–	–
	Collecting	Standard	Standard	–	–
	Rear discharge without collector	Standard	Standard	–	–
	Aerating	Standard	Standard	–	–
	Blade drive	Belt	Belt	–	–
	Verticutter blades	15	17	–	–
BLADES	Diameter of blades (mm)	163	163	–	–
	Aerating springs	14	16	–	–
	Grass catcher type	Soft bag, optional	Soft bag, optional	–	–
BAGGING	Grass catcher Optional (capacity) (l)	(196-640-000) 60	(196-640-000) 60	–	–
	Bag full indicator	–	–	–	–
	Wheels (F/R) (mm) / inches	(200 mm / 200 mm) 8" / 8"	(200 mm / 200 mm) 8" / 8"	(360 mm)	(355 mm)
WHEELS	Double ball bearings	Standard	Standard	–	pneumatic, agricultural
	Washing nozzle	–	–	–	–
COMFORT	Handle type	Ergonomic	Ergonomic	Standard	Standard
	Foldable handle	Standard	Standard	Standard	Standard
	Height adjustable handle	–	–	–	–
	Soft grip on the handle	–	–	–	–
	Handle grip at the front end	Standard	Standard	–	–
DIMENSIONS	Cub Cadet double action system	Scarifying & dethatching	Scarifying & dethatching	–	–
	LpA / LwA / LwAg (dB)	86 / 96 / 98	86 / 96 / 98	–	98 / 108 / 110
	Vib. value hand-arm / (K-factor)	5 / 1.5 m/s ²	5 / 1.5 m/s ²	–	5 / 2.5 m/s ²
	Dimensions (L / W / H) (cm)	124 / 61 / 112	124 / 61 / 112	140 / 55 / 100	172 / 61 / 114
	Weight net (kg)	38	39	31	104
Model number	16AH9AMQ603	16CH8AMQ603	25A-262E603	21BB45M8603	
EAN	 4 008423 872408 >	 4 008423 853223 >	 4 008423 881967 >	 4 008423 854015 >	

6

CHORE PERFORMERS

1

2

3

4

5

7

8

9





**MASSIVE POWER,
PRECISE
PERFORMANCE.**

ZERO-TURN TRACTORS.

Cub Cadet, the proven innovator of zero-turn technology, has created the industry's strongest line up of zero-turn riders. Our leading 360° turning technology lets you easily mow around obstacles with incredible confidence, making every mowing manoeuver more efficient. And with models that feature four-wheel steering, with steering wheel control you enjoy increased stability and faster cutting time.

XZ1

ENDURO SERIES™



PRECISE PERFORMANCE WITH LAP BAR TECHNOLOGY.

Built strong with heavy-duty components and high-performance commercial-grade engines, the XZ1 range delivers dependability and the professional results you and your customers demand.

Dual-adjustment lap bars and a high-back Cub Comfort™ seat make for the most spacious, comfortable zero-turn experience. An advanced cutting system design with optimal airflow, blade overlap and floating deck delivers flawless cutting performance.



TURNING TO THE LEFT:

To turn to the left, move the left drive control lever rearward of the right lever. The greater the distance between the two levers, the sharper the mower will turn.



DRIVING FORWARD:

Slowly and evenly move both drive control levers forward. The mower will start to move forward. To slow down the mower move the control levers rearward to attain the desired speed, or move the levers to the neutral position to stop the mower.

EXECUTING A ZERO-TURN:

To execute a zero-turn, move one control lever forward while simultaneously moving the other control lever back.

DRIVING REVERSE:

To drive the mower in reverse, slowly and evenly move both drive control levers back.



TURNING TO THE RIGHT:

To turn to the right, move the right drive control lever rearward of the left lever. The greater the distance between the two levers, the sharper the mower will turn.



DURABILITY

With a reinforced steel frame and chassis and a heavy-duty front axle, the XZ range is above all else, strong.



EASY ENTRY FRAME

A deep and wide frame makes getting on and off your XZ1 straight forward.



LEG ROOM

More than enough leg room for hours of comfortable operation and with a high back seat, this is one comfortable stick steer.



SOFT GRIP

The lap bars have soft grip features to make working more comfortable.



XZ1 107

Cutting width:	107 cm / 42 "
Engine:	Cub Cadet OHV, 547 cm ³
Rated power:	12.5 kW / 2,300 min ⁻¹
Drive:	Dual Hydrostatic

Model no.: 17CMCACS603

SPECIAL ORDER



XZ1 127

Cutting width:	127 cm / 50 "
Engine:	Kawasaki OHV V-Twin, 726 cm ³
Rated power:	12.0 kW / 2,400 min ⁻¹
Drive:	Dual Hydrostatic

Model no.: 17AICBDQ603

SPECIAL ORDER



XZ1 137

Cutting width:	137 cm / 54 "
Engine:	Kawasaki OHV V-Twin, 726 cm ³
Rated power:	12.5 kW / 2,500 min ⁻¹
Drive:	Dual Hydrostatic

Model no.: 17CICACW603

SPECIAL ORDER

XZ2 ENDURO SERIES™



STRENGTH, EASE AND VERSATILITY.

The XZ2 gives you more. Zero-Turn handling combined with the ease of steering-wheel control and four-wheel steering means unmatched stability and unprecedented versatility. An award-winning combination, there's no doubt in its strength of performance. With its incredible durability, there'll be no doubt for years to come.

The advanced cutting system with optimal airflow, blade overlap and floating deck delivers a consistent, flawless, high-quality cut. The dedicated dual hydrostatic rear-wheel transmission delivers effortless zero-turn control, synchronised with the steering to reduce turf damage which means that you can expect superior performance and an enviable lawn.

HYDROSTATIC



DUAL HYDROSTATIC TRANSMISSION

The dual hydrostatic transmission provides you with the highest manoeuvrability. Ground speed up to 7 mph forward and 4 mph in reverse.

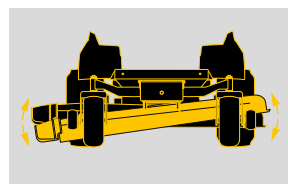

FLOATING CUTTING DECK

The floating deck follows the contours of the ground for superior cutting, providing a smoother and more uniform look.



REAR HITCH

All XZ2's can fit a hitch accessory. Product code 19A70025100.



COLLECT OR MULCH

Although the XZ2's are exceptional mulchers, collection is an option with a 200 l twin bag.

SYNCRO-STEER® TECHNOLOGY

UNBEATABLE MANOEVRABILITY AND UNMATCHED CLIMBING ABILITY

The Cub Cadet Syncro-Steer® technology is the next evolution of Zero-Turn technology. Our unique Zero-Turn riders with a traditional steering wheel provides you with the amazing manoeuvrability of a conventional Zero-Turn but with full control of the front wheels. Steering and drive are perfectly synchronised to ensure the exact speed and rotating direction of each rear wheel is in harmony with the front wheels. This revolutionary technology is available on all XZ2 mowers.



POWERED BY
Cub Cadet

3-in-1
OPTION



NEW

XZ2 107i

Cutting width:	107 cm / 42 "
Engine:	Cub Cadet OHV V-Twin, EFI 679 cm ³
Rated power:	13.1 kW / 2,700 min ⁻¹
Drive:	Dual Hydrostatic

Model no.: 17AWCBYS603



POWERED BY
Cub Cadet

3-in-1
OPTION



NEW

XZ2 117i

Cutting width:	117 cm / 46 "
Engine:	Cub Cadet OHV V-Twin, EFI 679 cm ³
Rated power:	13.1 kW / 2,700 min ⁻¹
Drive:	Dual Hydrostatic

Model no.: 17AWCBYT603



Powered by
Kawasaki

3-in-1
OPTION

NEW

XZ2 127

Cutting width:	127 cm / 50 "
Engine:	Kawasaki OHV V-Twin, 726 cm ³
Rated power:	12.0 kW / 2,400 min ⁻¹
Drive:	Dual Hydrostatic

Model no.: 17AICBYQ603

ZERO-TURNS

XZ3 ENDURO SERIES™



ZERO-TURNS. INFINITE STRENGTH.

High-performance meets practicality for one strong rider.

The Cub Cadet XZ3 122 has a heavy-duty, fabricated 122 cm / 48" deck with the versatility to mow around fences and trees. The easy-to-see centrally mounted deck maximises mowing accuracy in corners and under low obstacles. A low centre of gravity and wide wheelbase allow the machine to glide over uneven ground and still cut a completely straight line across hills and slopes. Tough terrain and steep hills are no problem with this added traction and control.

The advanced mulching technology incorporated in this machine re-circulates the airflow around the cutting deck delivering effective and efficient mulching capabilities. A superior mulcher.

HYDROSTATIC



DUAL HYDROSTATIC TRANSMISSION

The dual hydrostatic transmission provides you with the highest manoeuvrability. Ground speed up to 8 mph forward and 4 mph in reverse



FABRICATED CUTTING DECK

Every centimetre of the XZ3's heavy-gauge, welded steel cutting deck has been engineered to make sure you get unsurpassed airflow, blade overlap and quality of cut. Every time.

Picture for reference purposes only.



SYNCRO-STEER® TECHNOLOGY

Patented Syncro-Steer technology, pioneered by Cub Cadet, is a system of dual hydrostatic transmissions synchronised with steering-wheel control of all four wheels to create true zero-turn manoeuvrability. Not to mention, tremendous ease-of-use and stability.

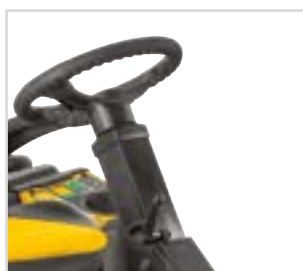

ADJUSTABLE STEERING COLUMN

The steering column is adjustable ensuring you find the perfect position to suit your height.



STEERING WHEEL

Soft grip steering wheel for great control in tough conditions.



HIGH BACK SEAT

With the high back seat with armrests the hard work will be done in comfort.



SIDE DEFLECTOR

Included is a practical side deflector so you can leave the grass on the lawn.



WHEELS

Steerable pneumatic front wheels which supports the Zero-Turn of your XZ3.



DECK WHEELS

Anti-scalping wheels provide a professional quality finish.

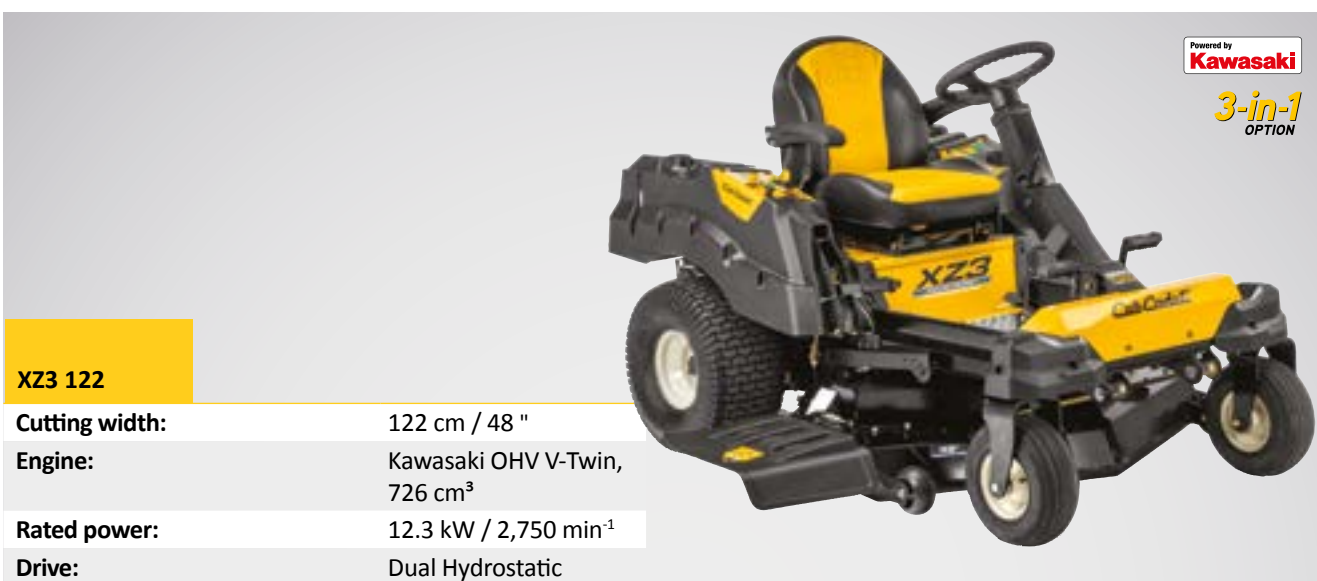



Powered by **Kawasaki**

3-in-1
OPTION

XZ3 122

Cutting width:	122 cm / 48"
Engine:	Kawasaki OHV V-Twin, 726 cm ³
Rated power:	12.3 kW / 2,750 min ⁻¹
Drive:	Dual Hydrostatic

Model no.: 17AIDGHB603

	XZ1 107	XZ1 127	
ENGINE	Engine type	Cub Cadet OHV	Kawasaki OHV
	Engine displacement	547 cm ³	726 cm ³
	Rated power	12.5 kW / 2,300 min ⁻¹	12.0 kW / 2,400 min ⁻¹
	Cylinders	Single	V-Twin
	Tank volume (capacity)	11.4 l	11.4 l
Lubrication		Full-pressure with spin-on oil filter	Full-pressure with spin-on oil filter
DRIVE SYSTEM	Transmission	Dual Hydrostatic	Dual Hydrostatic
	Speeds	Infinitely variable	Infinitely variable
	Control	Lap bars	Lap bars
	Cruise control	-	-
CUTTING SYSTEM	Mowing area in m ² /h	10,000	11,500
	Cutting width	107 cm / 42 "	127 cm / 50 "
	Cutting height (min-max)	38–100 mm	38–100 mm
	Cutting options	3-in-1 Option	3-in-1 Option
	Number of blades	2	3
	Deck engagement	Electric PTO	Electric PTO
	Deck height positions	8	8
	Deck wheels	2	4
DISCHARGE SYSTEM	Wash nozzle / mulching plug	Standard / Standard	Standard / Standard
	Bag (capacity in l) / accessory no	(200L) / (19C70020100)	(200L) / (19A70043100)
	Grass deflector	Standard	Standard
	Front axle	Steel	Steel
FRAME	Front bumper / rear bumper	-	-
	Turning radius (cm)	Zero	Zero
	Wheel size (front/rear)	11" x 4" / 18" x 8.5"	13" x 5" / 18" x 9.5"
	Wheel bearings	Ball bearings	Ball bearings
	Easy entry frame	Standard	Standard
ELECTRICAL SYSTEM	Battery	12 V Heavy-Duty	12 V Heavy-Duty
	Headlights	-	-
	Hour meter & service minder	Standard	Standard
	Safety systems	Operator presence	Operator presence
COMFORT	Seat type	High back	High back
	Seat adjustment	Quick adjuster lever	Quick adjuster lever
	Steering wheel	2-way adjustable lap bars with comfort grips	2-way adjustable lap bars with comfort grips
	Utility bin	Standard	Standard
	Mow in reverse (RevTEK™)	-	-
	Battery charger	(196-967-678)	(196-967-678)
DIMENSIONS	LpA / LwA / LwAg (dB)	88 / 98 / 100	93 / 103 / 105
	Vibration value body / (K-factor)	1 / 0.5 m/s ²	1 / 0.5 m/s ²
	Dimensions (L/W/H)	203 cm / 134 cm / 100 cm	213 cm / 140 cm / 100 cm
	Weight net	228 kg	253 kg
	Model number	17CMCACS603	17AICBDQ603
EAN	 4 008423 875492	 4 008423 857696	

XZ1 137

Kawasaki OHV
726 cm ³
12.5 kW / 2,500 min ⁻¹
V-Twin
11.4 l
Full-pressure with spin-on oil filter
Dual Hydrostatic
Infinitely variable
Lap bars
-
12,500
137 cm / 54 "
38–100 mm
3-in-1 Option
3
Electric PTO
8
4
Standard / Standard
(200L) / (19A70043100)
Standard
Steel
-
Zero
13" x 5" / 18" x 9.5"
Ball bearings
Standard
12 V Heavy-Duty
-
Standard
Operator presence
High back with armrests
Quick adjuster lever
2-way adjustable lap bars with comfort grips
Standard
-
(196-967-678)
93 / 103 / 105
1 / 0.5 m/s ²
213 cm / 148 cm / 100 cm
265 kg
17CICACW603
 4 008423 857689

1

6

3

4

5



6

7

ZERO-TURN SPECIFICATIONS



8

9

	XZ2 107i	XZ2 117i	
ENGINE	Engine type	Cub Cadet OHV EFI	Cub Cadet OHV EFI
	Engine displacement	679 cm ³	679 cm ³
	Rated power	13.1 kW / 2,700 min ⁻¹	13.1 kW / 2,700 min ⁻¹
	Cylinders	V-Twin	V-Twin
	Tank volume (capacity)	10.5 l	10.5 l
DRIVE SYSTEM	Lubrication	Full-pressure with spin-on oil filter	Full-pressure with spin-on oil filter
	Transmission	Dual Hydrostatic	Dual Hydrostatic
	Speeds	Infinitely variable	Infinitely variable
	Control	Dual foot pedal control	Dual foot pedal control
	Cruise control	Standard	Standard
CUTTING SYSTEM	Mowing area in m ² /h	10,000	10,500
	Cutting width	107 cm / 42 "	117 cm / 46 "
	Cutting height (min-max)	38 – 100 mm	38 – 100 mm
	Cutting options	3-in-1 Option	3-in-1 Option
	Number of blades	2	2
	Deck engagement	Electric PTO	Electric PTO
	Deck height positions	8	8
	Deck wheels	2	4
DISCHARGE SYSTEM	Wash nozzle / mulching plug	Standard / Standard	Standard / Standard
	Bag (capacity in l) / accessory no	/ (19C70020100)	/ (19C70020100)
	Grass deflector	Standard	Standard
FRAME	Front axle	Steel	Steel
	Front bumper / rear bumper	-/-	-/-
	Turning radius (cm)	Zero	Zero
	Wheel size (front/rear)	13" x 5" / 18" x 8.5"	13" x 5" / 18" x 8.5"
	Wheel bearings	Sleeve bearings	Sleeve bearings
	Easy entry frame	Standard	Standard
ELECTRICAL SYSTEM	Battery	12 V Heavy-Duty	12 V Heavy-Duty
	Headlights	-	-
	Hour meter & service minder	Standard	Standard
	Safety systems	Operator presence, brake switch, deck clutch switch	Operator presence, brake switch, deck clutch switch
COMFORT	Seat type	High back	High back
	Seat adjustment	Quick adjuster lever	Quick adjuster lever
	Steering wheel	Comfort	Comfort
	Utility bin	Standard	Standard
	Mow in reverse (RevTEK™)	Standard	Standard
	Battery charger	(196-967-678)	(196-967-678)
DIMENSIONS	LpA / LwA / LwAg (dB)	88 / 98 / 100	88 / 98 / 100
	Vibration value body / (K-factor)	1 / 0.5 m/s ²	1 / 0.5 m/s ²
	Dimensions (L/W/H)	203 cm / 116 cm / 118 cm	203 cm / 126 cm / 118 cm
	Weight net	234 kg	256 kg
	Model number	17AWCBYS603	17AWCBYT603
EAN	 4 008423 875478	 4 008423 875485	

XZ2 127

XZ3 122

Kawasaki OHV	Kawasaki OHV
726 cm ³	726 cm ³
12.0 kW / 2,400 min ⁻¹	12.3 kW / 2,750 min ⁻¹
V-Twin	V-Twin
10.5 l	2 x 10 l
Full-pressure with spin-on oil filter	Full-pressure with spin-on oil filter
Dual Hydrostatic	Dual Hydrostatic
Infinitely variable	Infinitely variable
Dual foot pedal control	Dual foot pedal control
Standard	-
11,500	11,000
127 cm / 50 "	122 cm / 48 "
38 – 100 mm	25 – 102 mm
3-in-1 Option	3-in-1 Option
3	3
Electric PTO	Electric PTO
8	15
4	2
Standard / Standard	Standard / Standard
/ (19A70043100)	/ (19A70040100)
Standard	Standard
Steel	Cast-iron
-	Standard/-
Zero	Zero
13" x 5" / 18" x 9.5"	13" x 5" / 20" x 10"
Sleeve bearings	Ball bearings
Standard	Standard
12 V Heavy-Duty	12 V Heavy-Duty
-	-
Standard	Standard
Operator presence, brake switch, deck clutch switch	Operator presence, brake switch, deck clutch switch
High back	High back with armrests and gel suspension
Quick adjuster lever	Quick adjuster lever
Comfort	Comfort
Standard	Standard
Standard	Standard
(196-967-678)	(196-967-678)
93 / 103 / 105	93 / 103 / 105
1 / 0.5 m/s ²	1 / 0.5 m/s ²
203 cm / 140 cm / 118 cm	194 cm / 124 cm / 118 cm
265 kg	312 kg
17AICBYQ603	17BIDGHB603
 4 008423 869798	 4 008423 875461

1

6

3

4

5

6

7

ZERO-TURN SPECIFICATIONS

8

9



PRO SERIES

PRO ZERO-TURNS.

The new PRO Series Zero-Turns are the strongest and most efficient line up of commercial mowers. Proven by landscape professionals, Cub Cadet commercial Zero-Turn mowers provide the ultimate performance, comfort and durability. From frame to front yoke, the PRO Zero-Turns are designed to handle the serious demands of professionals.

**ULTIMATE POWER,
FOR PROFESSIONAL
REQUIREMENTS.**



"EXTREMELY DURABLE. IT'S A POWERHOUSE."



DURABILITY – HEAVIEST DUTY.

From the frame to the front yoke, every part of the PRO Z is designed to handle demanding conditions. The thickness of the cutting deck establishes a new industry standard, while an all-around heavy-duty construction ensures this zero-turn will last for the long haul.

THE THICKEST, STRONGEST STEEL DECK IN THE INDUSTRY

Tackle the toughest conditions with the industry's only triple-7-gauge steel cutting deck: a 7-gauge deck shell with 7-gauge top and bottom reinforcements.



DURABILITY

- A** 1 / 4" leading rolled edge
- B** 5 / 16" steel side reinforcements
- C** 3 / 4" wear guard

QUALITY CUT

- D** Flexible rubber discharge chute
- E** High-lift Marbain® blades (with blade tip speed up to 18,500 fpm)
- F** Adjustable rear striping roller – optional on some models

BEEFED-UP FRONT END

Absorb the impact of rough terrain with a new front-end construction featuring a best-in-class combination of axle, hub and yoke size.

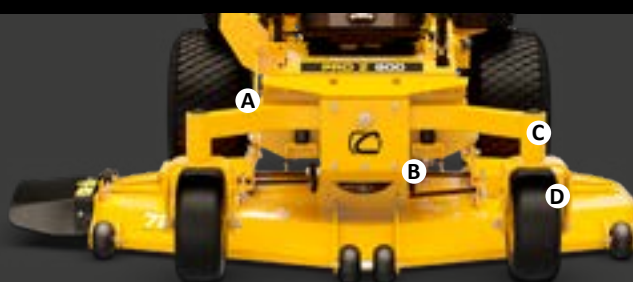

- A** 2" x 3" pivoting front axle
- B** Isolation dampening system
- C** 5" steel hubs
- D** 1/2" thick steel front yokes



"VERY COMFORTABLE AND EXTREMELY STURDY AT THE SAME TIME."

COMFORT — WORK HARD. RIDE EASY.

The PRO Z can take a beating, but your body shouldn't. Enjoy a smoother ride all day long with the enhanced comfort features of the PRO Z Series.

PRO Z AIR-RIDE SEAT
Our exclusive air-ride seat allows riders to adjust the seat firmness to their personal preference.

- A** Isolation dampening system under the seat (PRO Z 5/7)
- B** Lumbar support
- C** EVC cushion (elastic vibration control)
- D** Angle adjustment
- E** Padded armrests

PIVOTING FRONT AXLE
A pivoting front axle allows the front end of the PRO Z to negotiate unseen terrain while protecting the quality of the cut. The frame and axle float as the PRO Z moves, allowing the deck to follow the terrain profile and avoid scalping.

Cub Cadet®

POWERED BY
KOHLER.



**KOHLER CONFIDANT
EFI EZT 745**

Z1 137

The new Z-Turn Z1 137 exceeds your expectations, not your budget. Equipped with a powerful cutting deck, it always delivers professional-quality results. Its outstanding speed, efficiency and comfort impresses anybody who works daily with this zero-turn mower.

[103] PRO Z SERIES

Z1 137

TOP EFFICIENCY.
UNBELIEVABLE
MANOEUVRABILITY.



A POWER MACHINE

With its fast speed of 9.5 mph, the Z1 137 is at least twice as fast as a normal lawn tractor, excelling in efficiency

B MORE COMFORTABLE THAN EVER

High-comfort seat, suspension and non-slip controls guarantee safe and fatigue-free work

C MARKET-LEADING EFFICIENCY

25% less fuel consumption with electronic fuel injection (EFI)

D STRONG AND ROBUST

137 cm / 54" welded cutting deck for endless power

E EXTREMELY AGILE

The unique 360° turning circle technology helps you negotiate tight corners and obstacles easily, as well as being extremely sure footed on banks and slopes.

Cutting width:	137 cm / 54"
Recommended area capacity:	> 13,500 m ² /h
Mulching:	Standard
Engine:	KOHLER Confidant EFI EZT 745
Capacity:	747 cm ³
Drive:	Dual Hydrostat
Transmission:	Hydrogear ZT3400
Max. speed:	9.5 mph (forward) / 4.5 mph (reverse)
Cutting height adjustment:	15 positions
Steering control:	Steering wheel

Model no.: 53BWEFJA603

Powered by
Kawasaki



**KAWASAKI OHV,
V-TWIN DUAL CYLINDER**

Z5 152

Unbelievable strength plus unbeatable comfort – the perfect combination for real professionals! The new Zero-Turn Z5 152 delivers market-leading performance and quality with maximum efficiency. If you expect nothing but the very best from your mower, you'll be delighted with this, the ultimate Zero-Turn mower.

Z5 152

PERFECT IN EVERY DETAIL.



PIVOTING FRONT AXLE

A pivoting front axle allows the front end of the PRO Z to negotiate unseen terrain while protecting the quality of the cut. The frame and axle float as the PRO Z moves, allowing the deck to follow the terrain profile and avoid scalping.



Showing optional roller kit

THE THICKEST, STRONGEST STEEL DECK IN THE INDUSTRY

Tackle the toughest conditions with the industry's only 60 inch triple-7-gauge steel cutting deck: a 7-gauge deck shell with 7-gauge top and bottom reinforcements.

Cutting width:	152 cm / 60"
Recommended area capacity:	> 15,500 m ² /h
Mulching:	Standard
Engine:	Kawasaki OHV, V-TWIN dual cylinder
Capacity:	852 cm ³
Drive:	Dual Hydrostat
Transmission:	Parker HTG 12 cc
Max. speed:	10 mph (forward) / 5 mph (reverse)
Cutting height adjustment:	17 positions
Steering Control:	Steering wheel with power steering

Model no.: 53AIHJUV603*

Powered by
Kawasaki



**KAWASAKI OHV,
V-TWIN DUAL CYLINDER**

Z7 183

Amazing strength and unsurpassed comfort – the perfect combination for true professionals! The Z7 183 offers performance, quality and efficiency that puts other leading zero-turn mowers in the shade. This makes the Z7 183 the absolute top model that needs much less mowing time than any other product. However much you demand from a mower, you will love it!

Z7 183

THE ABSOLUTE POWER
PACK FOR TOP
REQUIREMENTS.



NEW



PRO Z AIR-RIDE SEAT

Our exclusive air-ride seat allows riders to adjust the seat firmness to their personal preference.



MAINTENANCE FREE SPINDLE

Slash downtime thanks to Cub Cadet's new spindle design. Completely sealed, dual double-row ball bearings make the spindle maintenance-free for its lifetime, and anti-friction washers prevent self-tightening, meaning easier blade maintenance.

Cutting width:	183 cm / 72"
Recommended area capacity:	> 18,000 m ² /h
Mulching:	Standard
Engine:	Kawasaki OHV
Capacity:	999 cm ³
Drive:	Dual Hydrostat
Transmission:	Parker HTG 14 cc
Max. speed:	12 mph (forward)/6 mph (reverse)
Cutting height adjustment:	17 positions
Steering Control:	Steering wheel with power steering

Model no.: 53RIHKUY603

		Z1 137		
ENGINE	Engine type	KOHLER Confidant EFI EZT 745		
	Engine displacement	747 cm ³		
	Rated power	14.4 kW / 2,300 min ⁻¹		
	Cylinders	V-TWIN dual cylinder		
	Tank volume (<i>capacity</i>)	2 x 13 l		
	Lubrication	pressure oil lubrication		
	Transmission	Hydrogear ZT3400		
	Mowing area	13,500 m ² /h		
CUTTING SYSTEM	Cutting width	137 cm / 54"		
	Cutting height (<i>min.-max.</i>)	26–127 mm		
	Cutting options	2-in-1		
	Number of blades	3		
	Deck engagement	Electric PTO		
	Deck height positions	15		
	Deck wheels	4 + 2 Nose		
	Wash nozzle/Mulch Kit	-/Standard		
DISCHARGE SYSTEM	Bag (<i>capacity</i>) /accessory no	-		
	Grass deflector	Standard		
	Front bumper/rear bumper	-/Standard		
	Turning circle	Zero cm		
	Wheel size (<i>front/rear</i>)	13" x 6.5" / 24" x 12"		
	Wheel bearings	Ball bearings		
	Battery	230 CCA		
	Headlights	-		
ELECTRICAL SYSTEM	Hour meter & service minder	Standard		
	Safety systems	Rollover bar		
	Seat type	High back, Adjustable		
	Seat adjustment	Quick adjuster lever		
	COMFORT	Steering wheel	Soft-Grip	
		Utility bin	-	
		Mow in reverse (<i>RevTEK™</i>)	Standard	
		Battery charger	-	
DIMENSIONS	LpA/LwA/LwAg (dB)	93/103/105		
	Vibration value body /K-Faktor	1 / 0.5 m/s ²		
	Net weight	360 kg		
	Model number	53BWEFJA603		
ACCESSORIES	Deck lift	Power Deck Lift (19A70045100)		
	Striping kit	Heavy-Duty Deck-mounted Striping Kit (19A70019100)		
	EAN	 4 008423 874273		

	Z5 152	Z7 183
	Kawasaki OHV	Kawasaki 999 cc 31 HP
	852 cm ³	999 cm ³
	17.15 kW / 2,500 min ⁻¹	21 kW / 2,650 min ⁻¹
	V-TWIN dual cylinder	V-TWIN dual cylinder
	2 x 28 l	2 x 28 l with fuel gauge
	pressure oil lubrication	pressure oil lubrication
	Parker HTG 12 cc	Parker HTG 14 cc
	15,500 m ² /h	> 18,000 m ² /h
	152 cm / 60"	183 cm / 72"
	26–127 mm	26–127 mm
	2-in-1	2-in-1
	3	3
	Electric PTO	Electric PTO
	17	17
	2 + 2 nose rollers	4 + 2 nose + 1 deck rear rollers
	-/Standard	-/Standard
	-	-
	Standard	Standard
	-/Standard	-/Standard
	Zero cm	Zero cm
	15" x 6" / 24" x 12"	16" x 6.5" / 24" x 12"
	Ball bearings	Ball bearings
	230 CCA	230 CCA
	-	-
	Standard	Standard
	Rollover bar	Rollover bar
	High back with armrests, Adjustable	High back with armrests, Adjustable
	Quick adjuster lever	Quick adjuster lever
	Soft-Grip	Soft-Grip
	-	-
	Standard	Standard
	-	-
	93/103/105	93/103/105
	1 / 0.5 m/s ²	1 / 0.5 m/s ²
	680 kg	732 kg
	53AIHJUV603	53RIHKUY603
	Electronic/Power Deck Lift Kit (59A30050150)	Electronic/Power Deck Lift Kit (59A30050150)
	Heavy-Duty Deck-mounted Striping Roller Kit (59A30052150)	-
	 4 008423 872415	 4 008423 881929

LAWN TRACTOR ACCESSORIES.







LAWN TRACTOR COVER L / XL

Size L: for small and medium sized lawn tractors



Size XL: for large sized and rear discharge lawn tractors



TOW SPREADERS

ATV spreader, volume 80 kg hopper capacity
(measurements: approx. L 109 / W 96 / H 104 cm,



Tow broadcast spreader, volume 39 kg hopper capacity
(measurements: approx. L 88 / W 55 / H 60 cm,



Tow broadcast spreader, volume 49 kg hopper capacity
(measurements: approx. L 67 / W 67 / H 36 cm)



Tow behind broadcast spreader, 56 kg hopper capacity
(measurements: approx. L 45 / W 27 / H 32 cm)



PUSH SPREADERS

Push Broadcast Spreader, 39 kg volume, hopper capacity
(measurements: approx. L 89 / W 56 / H 84 cm)



Push Spreader, 49 kg volume, hopper capacity
(measurements: approx. L 109 / W 66 / H 97 cm)



Push Spreader, 56 kg volume, hopper capacity
(measurements: approx. L 48 / W 27 / H 33 cm)



Push Salt Spreader, 59 kg volume, hopper capacity
(measurements: approx. L 122 / W 85 / H 69 cm)



LAWN SWEEPER

Tow lawn sweeper, width 72 cm, 340 litres, steel
(measurements: approx. L 182 / W 114 / H 58 cm,
weight: approx. 30 kg)



Tow lawn sweeper, width 112 cm, 708 litres, steel
(measurements: approx. L 199 / W 140 / H 132 cm,
weight: approx. kg)

Mod. no.: 45-0492

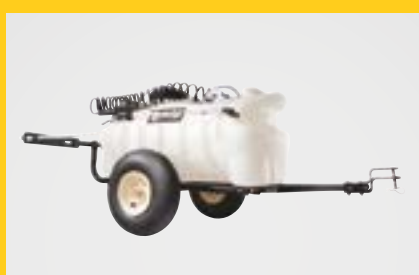

SPRAYERS

Tow sprayer, large, 15 gallon
(measurements: approx. L 139 / W 66 / H 50 cm)



Tow sprayer, extra large 25 gallon
(measurements: approx. L 139 / W 71 / H 55 cm)





UTILITY CART WITH POLY BED

Poly convertible push / tow cart , capacity max. 159 kg (measurements: approx. L 142 / W 83 / H 76 cm)



UTILITY CARTS WITH STEEL BED

Tow steel dump cart, capacity max. 227 kg (measurements: approx. L 152 / W 83 / H 72 cm, weight: approx. 33 kg)



Tow steel dump cart, capacity max. 340 kg, steel (measurements: approx. L 177 / W 83 / H 73 cm, weight: approx. 43 kg)



TRAILER

Tow behind ATV trailer with easy empty bed swivel

- Capacity: 450 kg
- Volume: 425 litres



LAWN ROLLERS

Push / tow poly lawn roller, max. weight 114 kg when filled with water (measurements: approx. L 127 / W 76 / H 45 cm)



Tow poly lawn roller, max. weight 182 kg when filled with water, (measurements: approx. L 127 / W 106 / H 45 cm)



Tow poly roller, max. weight 249 kg when filled with water (measurements: approx L 127 / W 122 / H 45 cm)



AERATORS / DE-THATCHER

Tow tine de-thatcher, 20 teeth (heat treated tines), steel (measurements: approx. L 102 / W 105 / H 105 cm)



Tow lawn aerator (spiker type) 101.6 cm, 12 spike wheels (spiker), steel (measurement: approx. L 101 / W 104 / H 104 cm, weight: approx. 20 kg)



Tow lawn aerator, 24 durable spring tines, steel (measurement: approx. L 102 / W 122 / H 105cm)



DEFLECTORS

Rear deflector for LT Series rear-discharge models



Rear deflector for all CC 1000 rear-discharge models



Rear deflector for XT Series rear-discharge models





MULCH KITS

Mulch kit for all CC 1000 rear-discharger models



Mulch kit (without blades) for model LT1 NS96



Mulch kit (without blades) for models LT1 NR92, LT2 NR92 and LT3 PR105



For 106 cm decks (without blades)
Models XT1, XT2 and XT3 rear discharge
Blade Kit 196-560-000



For 95 cm decks (without blades)
Models XT1, XT2 and XT3 rear discharge
Blade Kit 196-561-000



ELECTRIC SPREADER FOR XT-RANGE

Electric spreader for all XT models



STEEL CARGO CARRYING PLATFORM FOR XT RANGE

Can be folded up vertically and secured



DUST SKIRT

XT RANGE 360 litres Dust Skirt for Anti Dust System
For XT3 rear collection



XT RANGE 320 litres Dust Skirt for Anti Dust System
For XT1 and XT2 rear collection



GRASS BAGS

Triple bagger, 210 litres, for XT3 QS127 and XT3 QS137



Twin bagger for 107 / 117 cm decks XT1 and XT2 models



Bag for LT range 96 cm and 107 cm



Bag for LR1 and LR2



Bag for XZ1 127 and XZ2 127



Bag for XZ3 122



Bag for XZ1 107, XZ2 107i & XZ2 117i





FRONT BUMPER

Front bumper kit - FastAttach™ fits all LT series lawn tractors

4 008423 809046
Mod. no.: OEM-196B603



AGRICULTURAL TYRES

Chevron style rear wheels 18" x 9.5". Set exists of 2 complete wheels. Fits all tractors with either 18" or 20" rear wheels.

4 008423 816891
Mod. no.: 196-721A-678

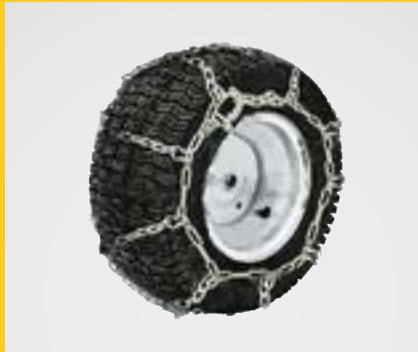

TYRE CHAINS

Tyre chains 20" x 8" incl. adapter

4 008423 824797
Mod. no.: 196-658-699

Tyre chains for XT 18" X 8.5" wheels for rear discharge models

0 037049 945559
Mod. no.: 490-241-0021

Tyre chains for XT side discharge

0 037049 945597
Mod. no.: 490-241-0025



DOZER BLADE AND RUBBER LIP

117 cm dozer blade for all models

4 008423 807684
Mod. no.: OEM-190-833

Rubber lip - universal - for all dozer blades

4 008423 815368
Mod. no.: 196-718-678



DOZER BLADE

Fits XT range

Mod. no.: 19A300170EM

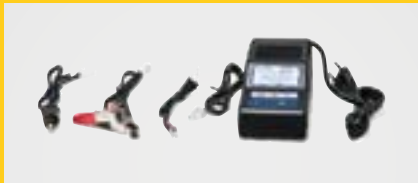

BATTERY CHARGER

Electric battery charger with 12V plug, 1000 mA for all tractor models, with trigger charge function (for battery winter maintenance) excluding XT models

4 008423 835694
Mod. no.: 196-967-678



ELECTRIC GRASS CATCHER

Electric grass catcher emptying mechanism for XT models rear discharge (models starting 13B)

4 008423 882025 >
Mod. no.: 196-570-600

ADDITIONAL XT ACCESSORIES	
Front bumper single XT models	4 008423 876086 Mod. no.: 196-562-000
Front bumper loop XT models	4 008423 876093 Mod. no.: 196-563-000
Armrests for XT2 and XT3 models	4 008423 876055 Mod. no.: 196-564-603

MOD. NO.	DESCRIPTION	EAN CODE	Z		
			Z1 137	Z5 152	Z7 183
PRO SERIES ACCESSORIES					
490-241-0026	Snow chains for Z1	0037049945603	•		
490-241-0036	Snow chains for Z5 & Z7	0037049951123		•	
19B70044100	Dozer blade for Z1	4008423881172	•		
59B30036150	Dozer blade for Z5 & Z7	0043033580255		•	
19B70045100	Electric deck lift kit for Z1	4008423881189	•		
59A30050150	Electric deck lift kit for Z5 and Z7	0043033576340		•	•
19A70019100	Heavy duty lawn striping kit for Z1	0043033565085	•		
59A30052150	Heavy duty lawn striping kit for Z5	0889021121587		•	

WARRANTY

Cub Cadet offers a three year domestic user warranty across the entire range of garden machinery. This is great news for both customers and dealers, inspiring confidence in the quality and reliability of Cub Cadet products.

Details of terms and conditions can be found at www.cubcadet.co.uk.

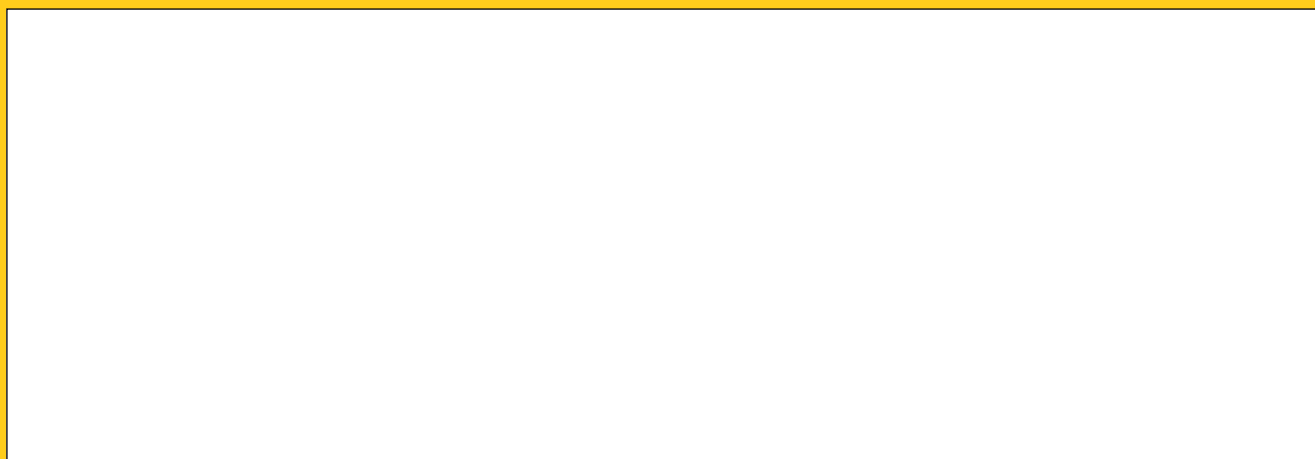

Text and photographs, specifications of dimensions and performance are composed with greatest care. The correctness of the information cannot be guaranteed, especially it is not guaranteed that the products comply with the images regarding colour, form and equipment or that the products comply with the proportion of the images. The engine horsepower information provided by the engine manufacturer is to be used for comparison purposes only. Amendments due to misprints or errors are reserved.

Please see the operator's manual and the warning labels posted on the vehicle itself for more details.

Division of E. P. Barrus Ltd, Glen Way, Launton Road, Bicester, Oxfordshire. OX26 4UR.
Tel: 01869 363658 Fax: 08714 290936



www.cubcadet.co.uk